

SOC HEADQUARTERS

DORÉ  
ARCHITECTS

ege | int | dore  
E I D  
construction









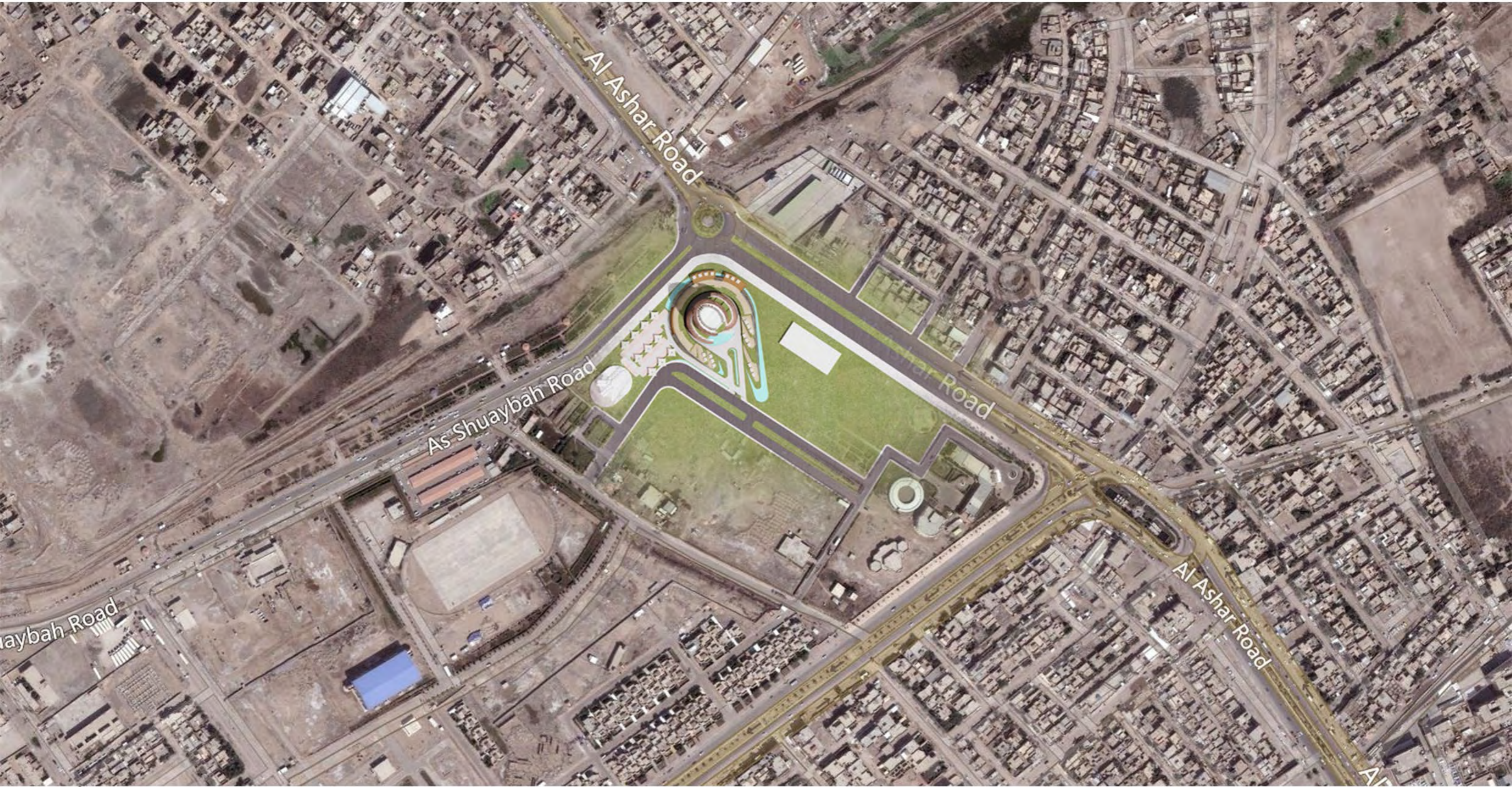





SITE PLAN











1. Logo as the plan of the structure



2. Rotation of the drop



3. Main block (The Drop)

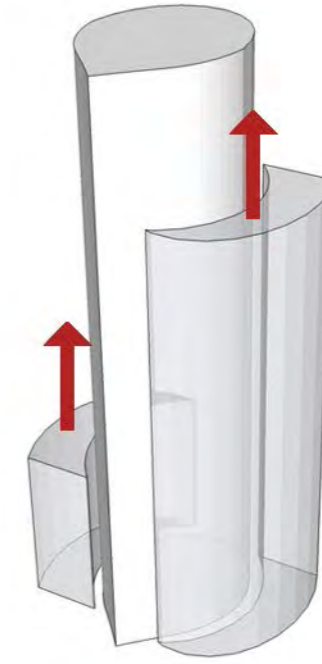

4. Secondary blocks (The Curves)

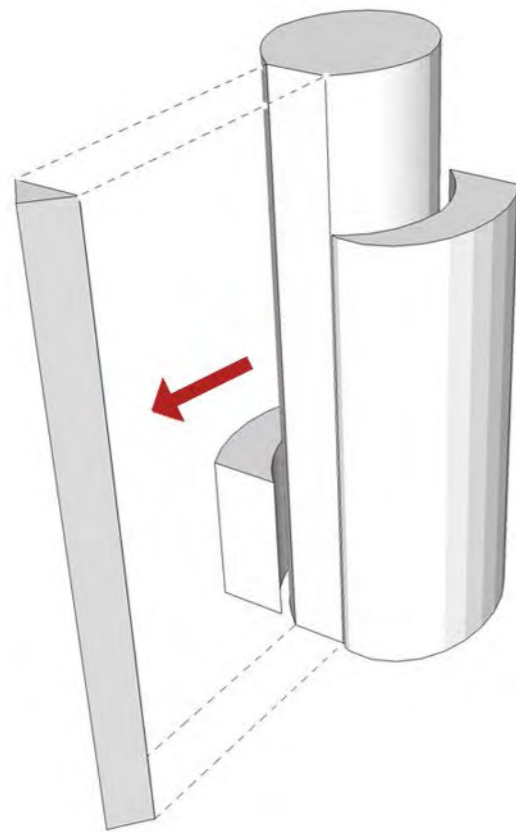

5. Subtraction of edge

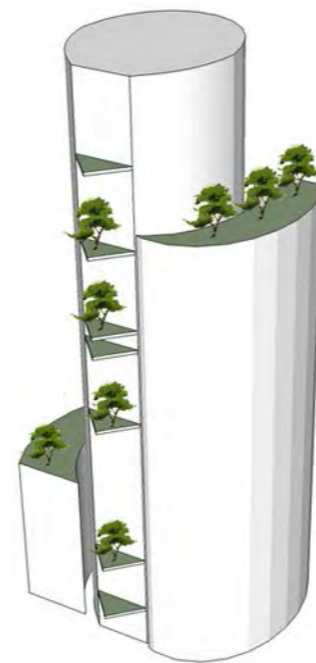

6. Re-introduction of edge as terraces

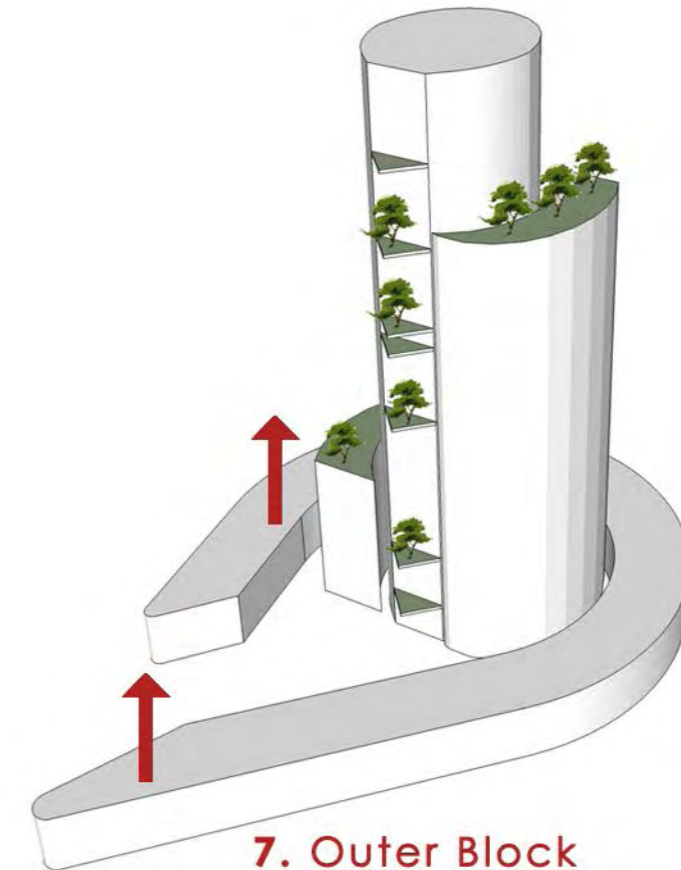

7. Outer Block (The Big Drop)





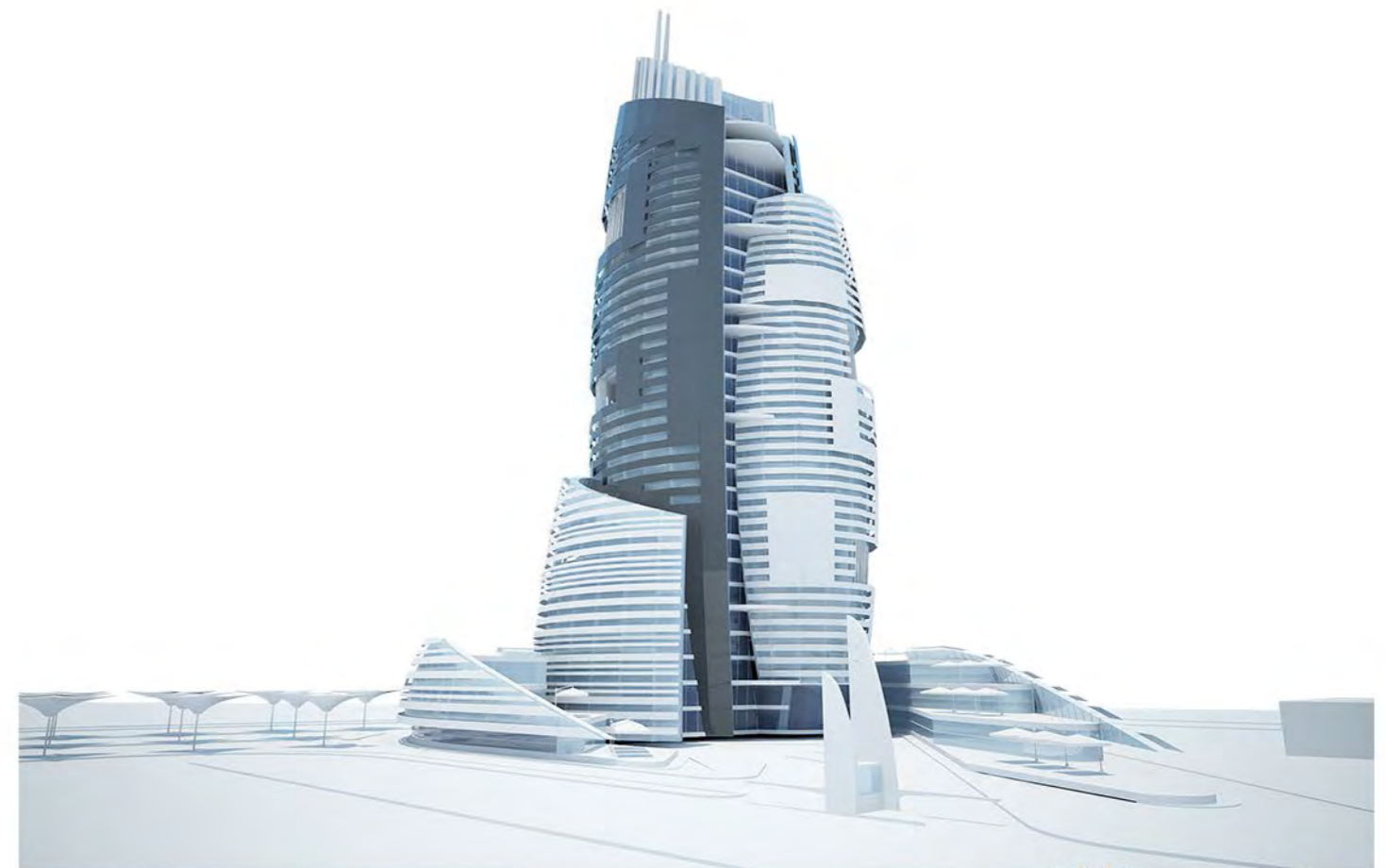



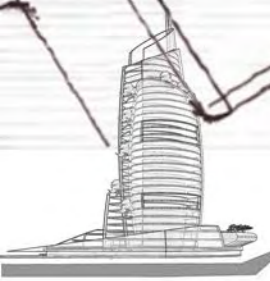
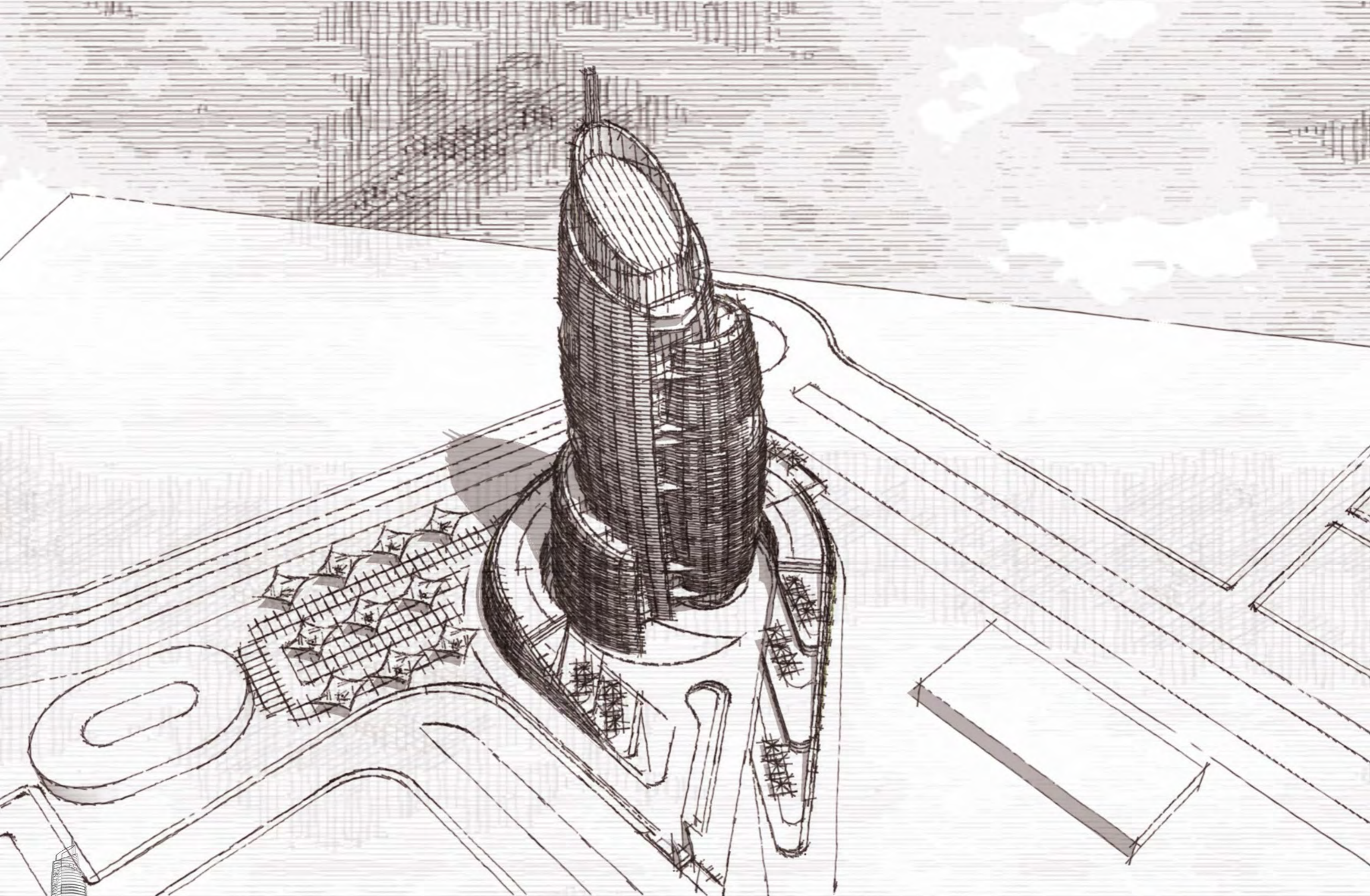

SKETCH

egeIntIdore  
**E I D**  
construction

**DORE**  
ARCHITECTS



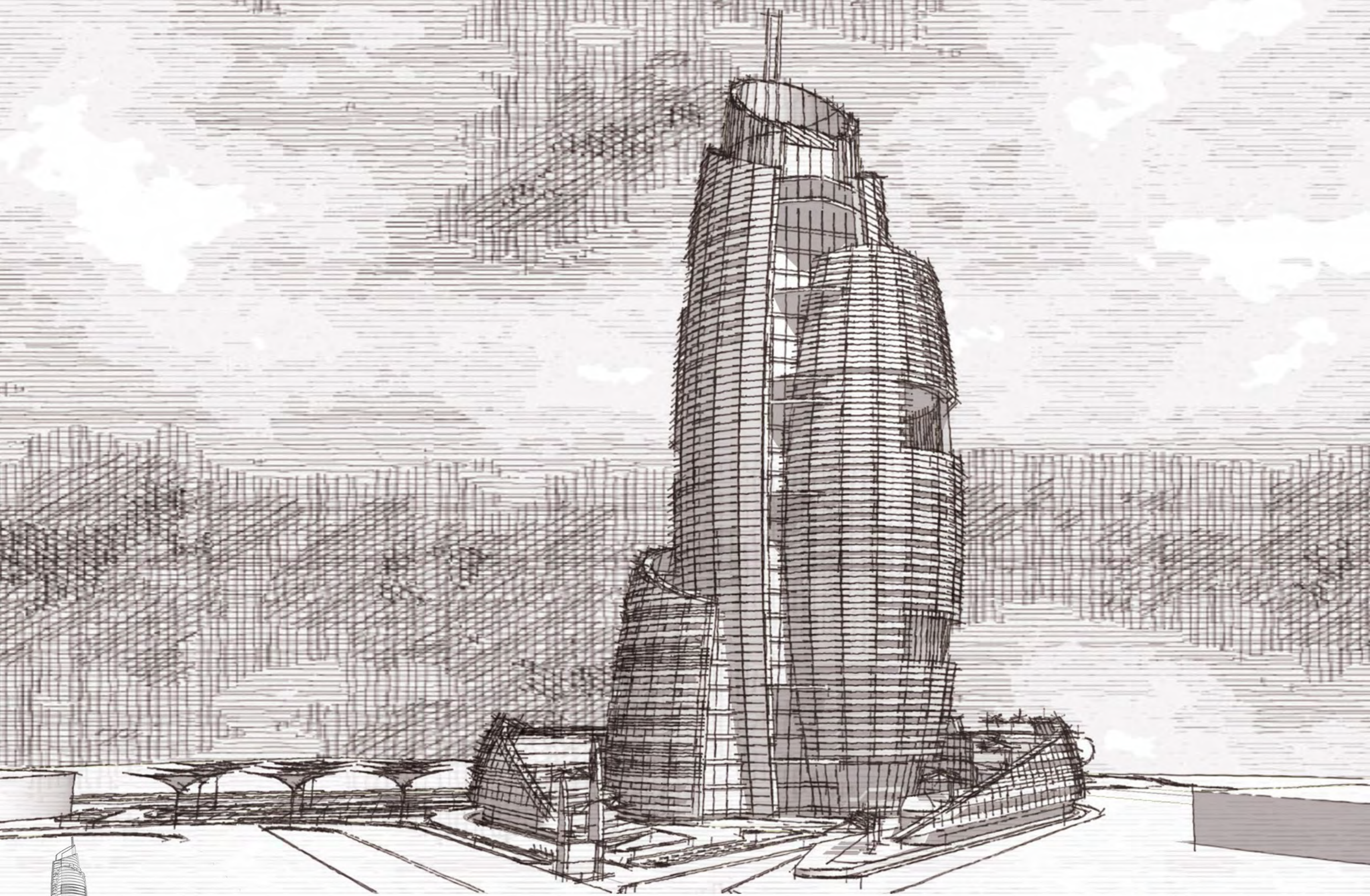

SKETCH

egetintidore  
**E I D**  
construction

**DORE**  
ARCHITECTS



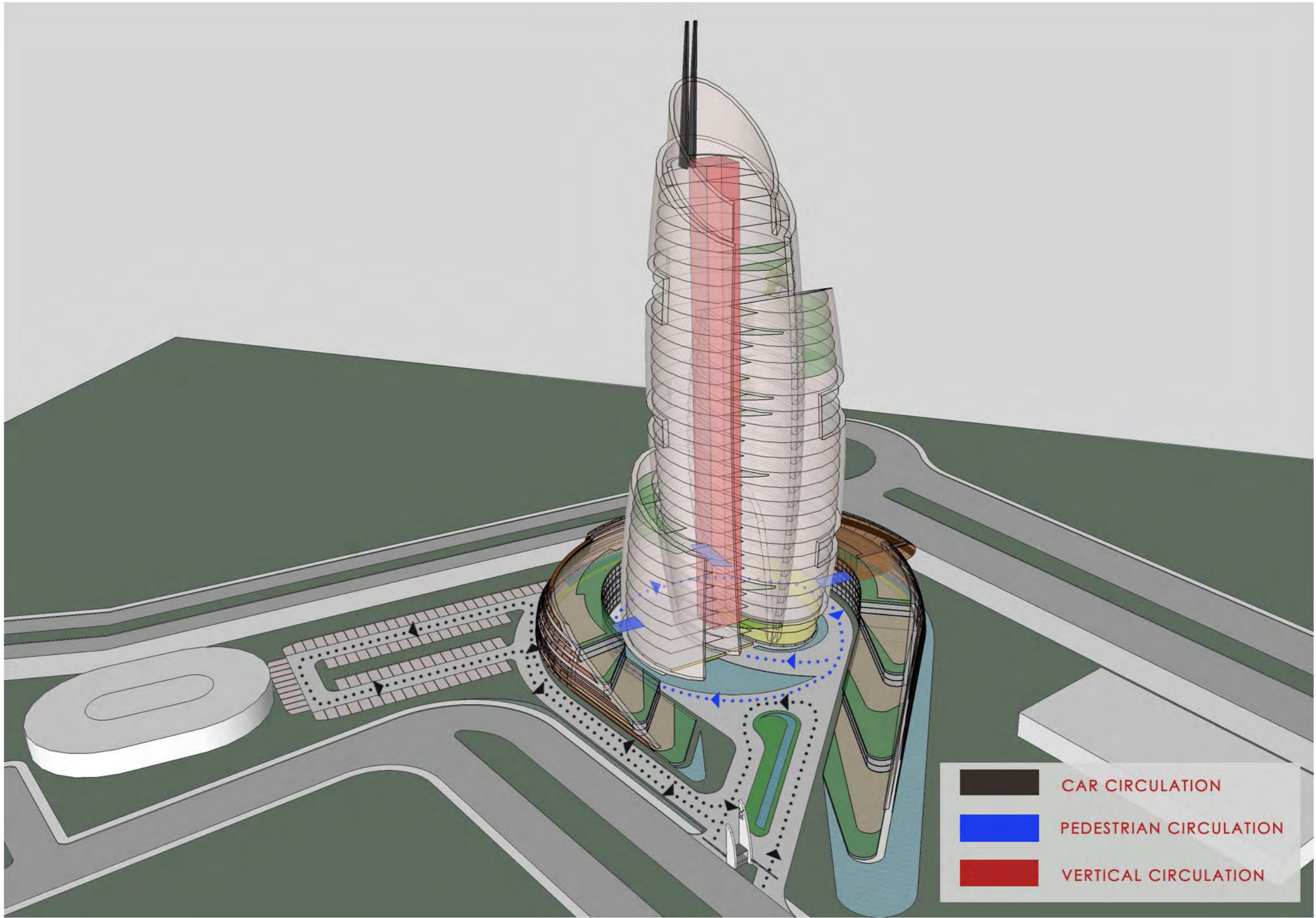

CIRCULATION DIAGRAM







**SOLAR CONTROL**  
Special solar control units will be designed for the sunroof on the top floor

**SOLAR CONTROL**



**PV PANELS**



**SKY GARDENS**

**RAIN WATER TANKS**







ADMINISTRATIVE FLOORS  
(H: 4m)

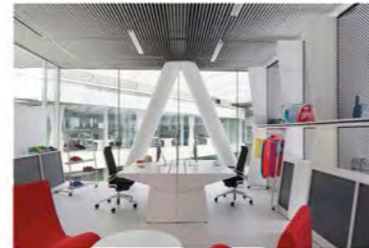

OFFICE FLOORS  
(H: 4m)



LIBRARY AND LOUNGE  
FLOORS



SKY LOBBY  
RESTAURANT FLOOR  
(H: 8m)



SKY GARDEN



MAIN ENTRANCE



CONFERENCE HALL

MEETING ROOMS

FITNESS CENTRE

CAFETERIA

SECTION







PERFORATED PLATE FOR SOLAR CONTROL

CURTAIN WALL

STRUCTURAL ELEMENTS



RAISED FLOOR

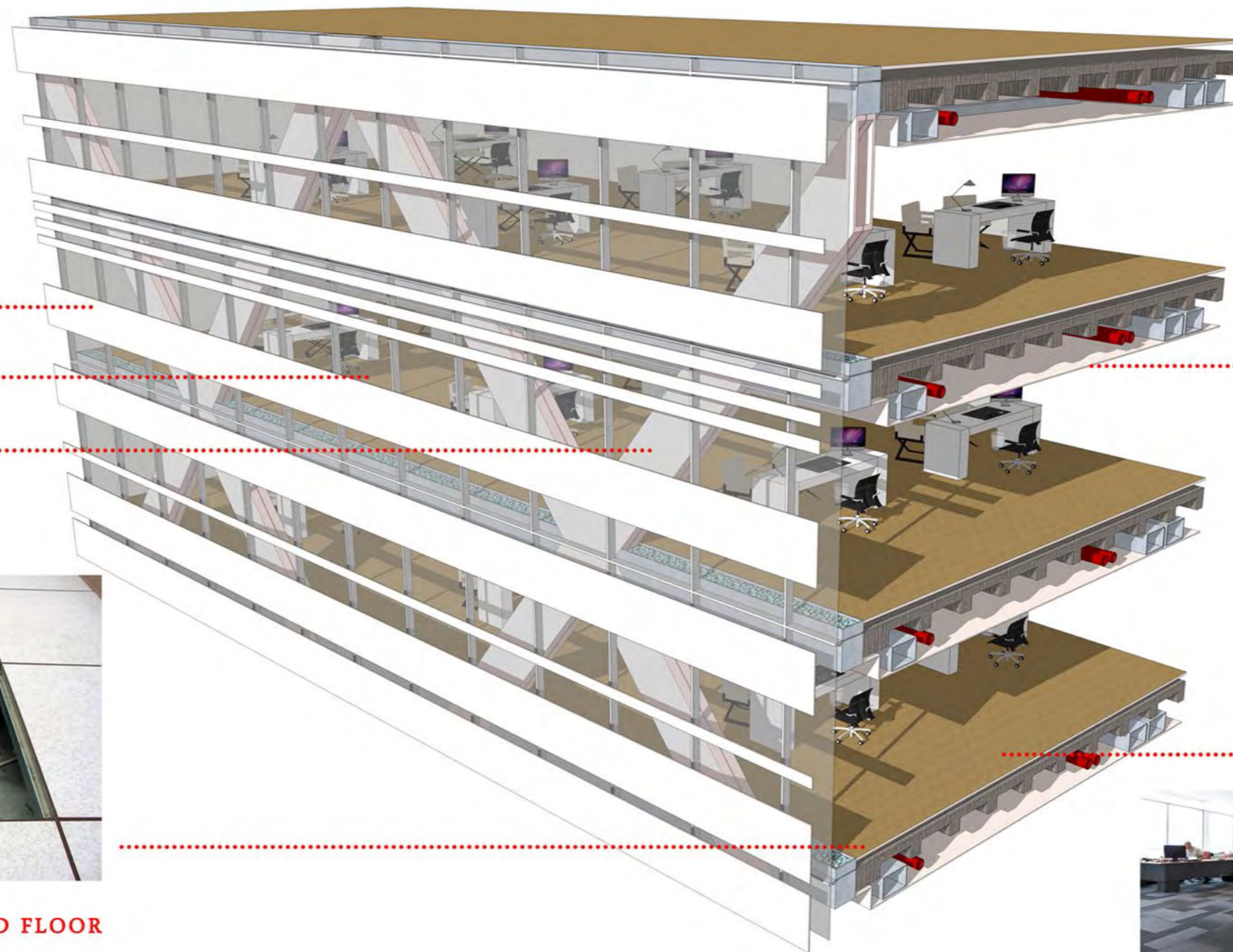

SUSPENDED CEILING

CARPET TILES







RAISED FLOOR



CARPET TILES

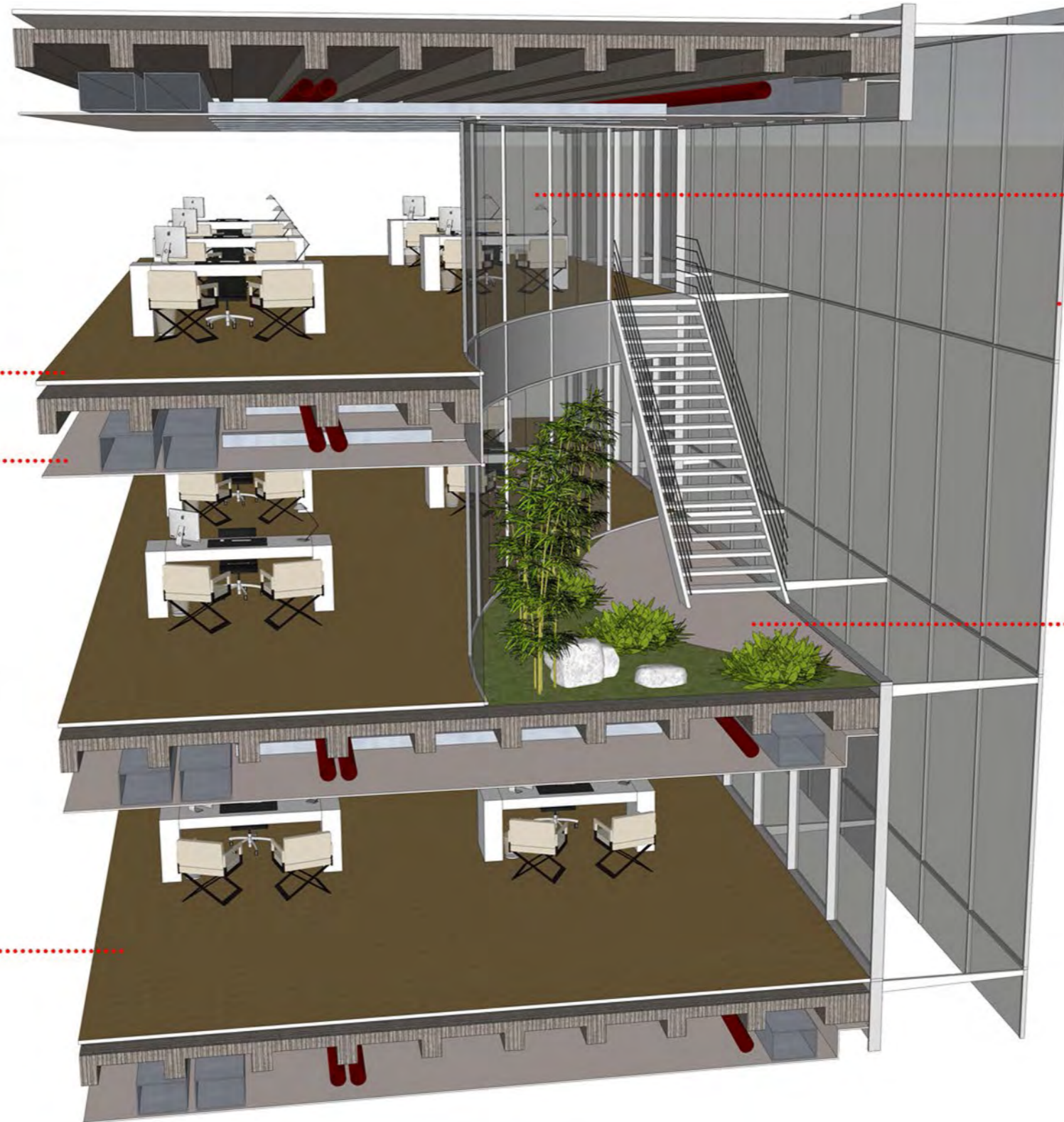

SUSPENDED CEILING

CURTAIN WALL

SECOND FACADE

INNER GARDEN







FRONT VIEW (SOUTHEAST FAÇADE)





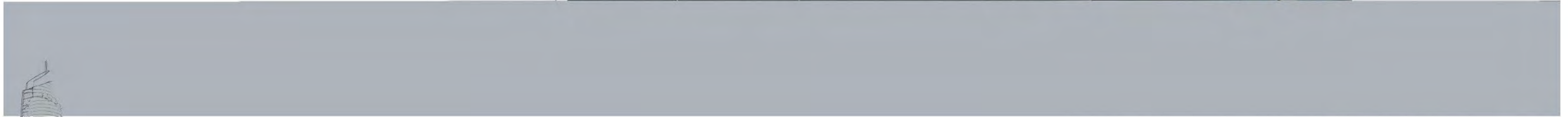
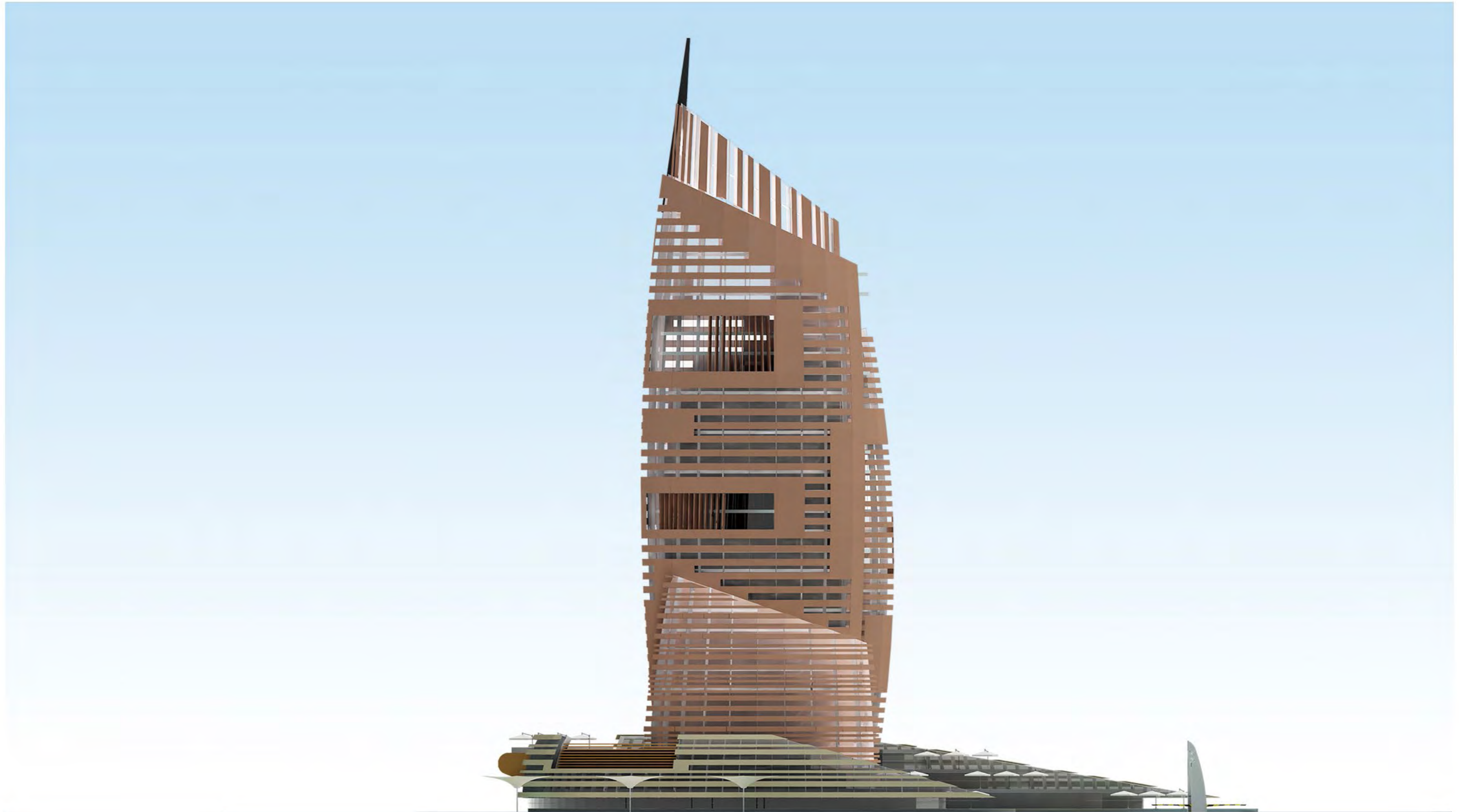

SOUTHWEST FAÇADE

E I D  
egetintidore  
construction

DORE  
ARCHITECTS



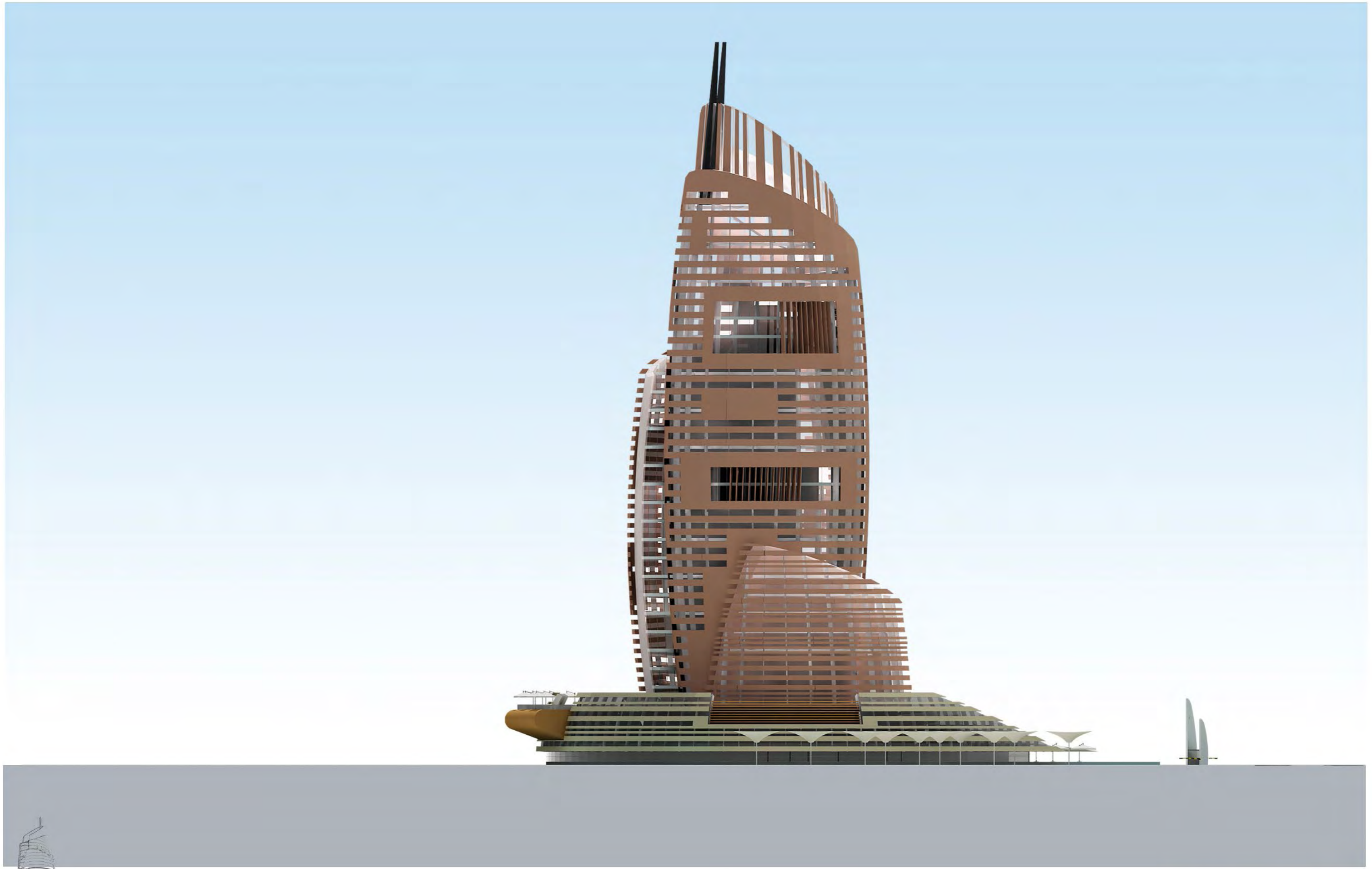

WEST FAÇADE

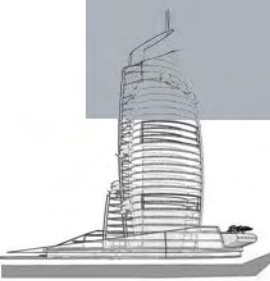





NORTH FAÇADE

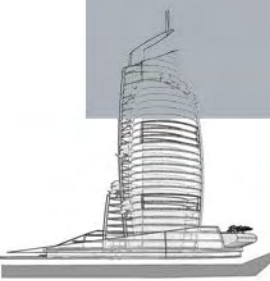



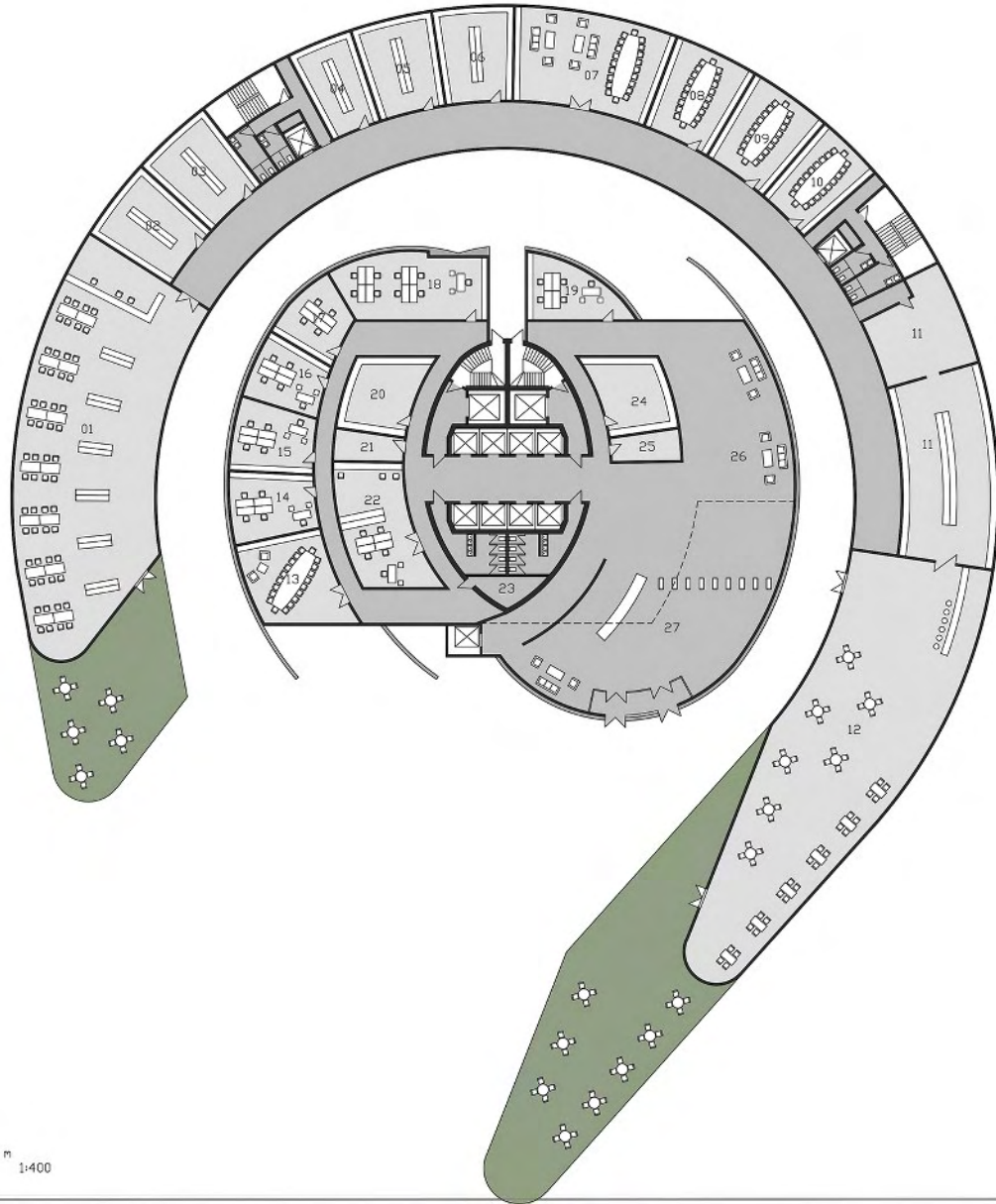

01	LIBRARY	407m <sup>2</sup>
02	ARCHIVE ROOM	55m <sup>2</sup>
03	ARCHIVE ROOM	55m <sup>2</sup>
04	ARCHIVE ROOM	43m <sup>2</sup>
05	ARCHIVE ROOM	54m <sup>2</sup>
06	ARCHIVE ROOM	54m <sup>2</sup>
07	MEETING ROOM	110m <sup>2</sup>
08	MEETING ROOM	56m <sup>2</sup>
09	MEETING ROOM	56m <sup>2</sup>
10	MEETING ROOM	46m <sup>2</sup>
11	KITCHEN	214m <sup>2</sup>
12	CAFETERIA	447m <sup>2</sup>
13	MEETING ROOM	62m <sup>2</sup>
14	OFFICE	42m <sup>2</sup>
15	OFFICE	41m <sup>2</sup>
16	OFFICE	35m <sup>2</sup>
17	OFFICE	32m <sup>2</sup>
18	FIRE MONITORING	73m <sup>2</sup>
19	SECURITY	38m <sup>2</sup>
20	STORAGE	43m <sup>2</sup>
21	AC ROOM	15m <sup>2</sup>
22	CONTROL/MONITORING	72m <sup>2</sup>
23	TECHNICAL AREA	12m <sup>2</sup>
24	ELECTRIC ROOM	43m <sup>2</sup>
25	AC ROOM	15m <sup>2</sup>
26	ENTRANCE	261m <sup>2</sup>
27	ATRIUM	225m <sup>2</sup>
GRSS OFFICE AREA		275m <sup>2</sup>

0 5 10 20 m 1:400

GROUND FLOOR



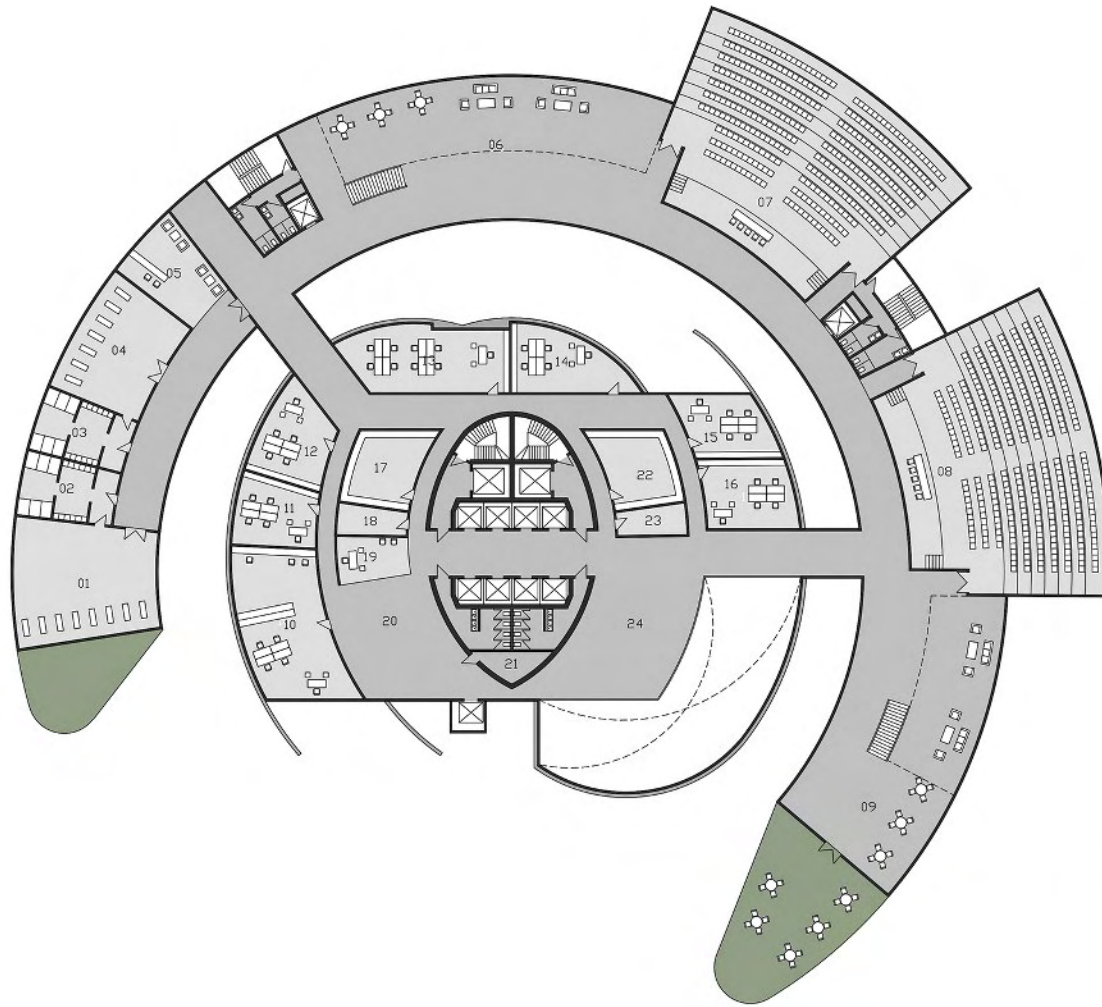

01	FITNESS	126m <sup>2</sup>
02	CHANGING ROOM	43m <sup>2</sup>
03	CHANGING ROOM	43m <sup>2</sup>
04	FITNESS	88m <sup>2</sup>
05	RECEPTION	48m <sup>2</sup>
06	FOYER	383m <sup>2</sup>
07	MULTI-PURPOSE HALL	393m <sup>2</sup>
08	MULTI-PURPOSE HALL	393m <sup>2</sup>
09	FOYER	307m <sup>2</sup>
10	CONTROL/MONITORING	113m <sup>2</sup>
11	OFFICE	41m <sup>2</sup>
12	OFFICE	39m <sup>2</sup>
13	FIRE MONITORING	79m <sup>2</sup>
14	SECURITY	49m <sup>2</sup>
15	OFFICE	42m <sup>2</sup>
16	OFFICE	48m <sup>2</sup>
17	STORAGE	43m <sup>2</sup>
18	AC ROOM	15m <sup>2</sup>
19	SECRETARY	22m <sup>2</sup>
20	LOUNGE	48m <sup>2</sup>
21	TECHNICAL AREA	12m <sup>2</sup>
22	ELECTRIC ROOM	43m <sup>2</sup>
23	AC ROOM	15m <sup>2</sup>
24	LOUNGE	22m <sup>2</sup>
GRSSS OFFICE AREA		223m <sup>2</sup>



0 5 10 20 m 1:400

1. FLOOR



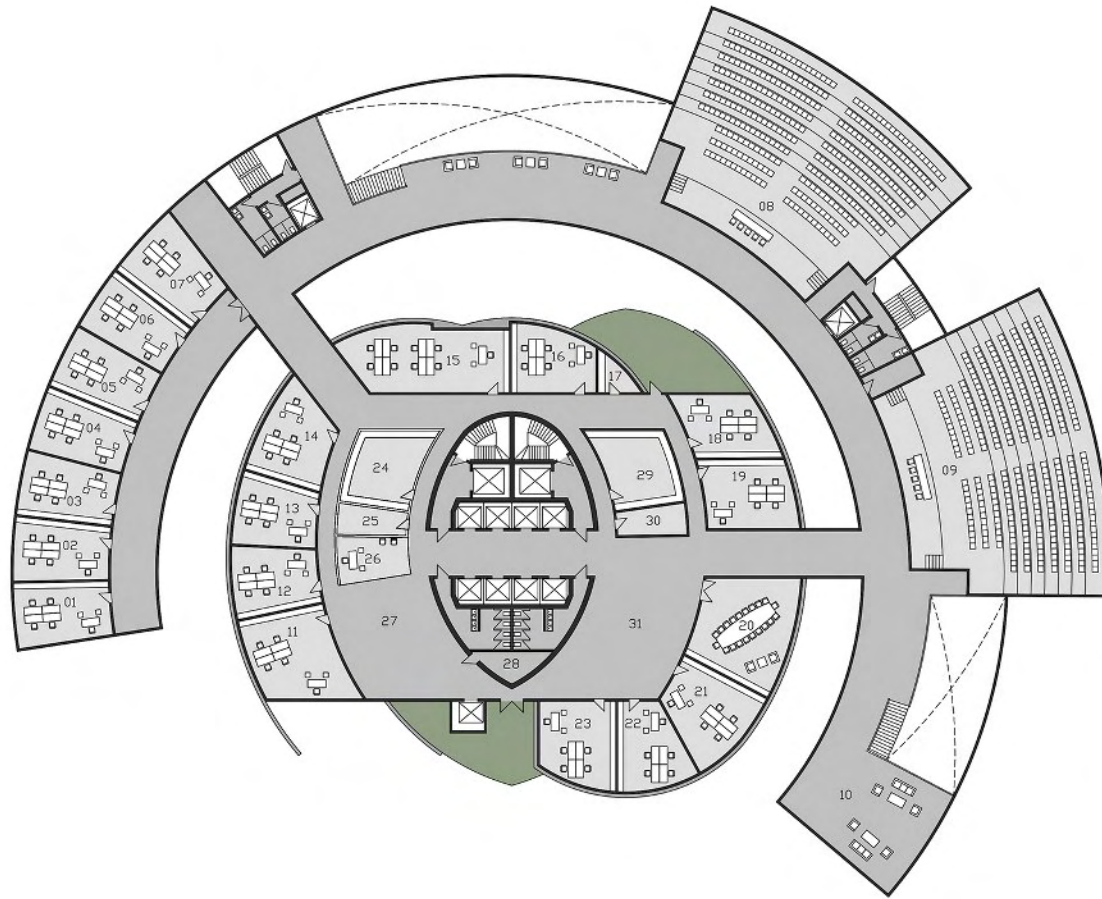

01	OFFICE	44m <sup>2</sup>
02	OFFICE	43m <sup>2</sup>
03	OFFICE	43m <sup>2</sup>
04	OFFICE	43m <sup>2</sup>
05	OFFICE	43m <sup>2</sup>
06	OFFICE	43m <sup>2</sup>
07	OFFICE	48m <sup>2</sup>
08	MULTI-PURPOSE HALL	393m <sup>2</sup>
09	MULTI-PURPOSE HALL	393m <sup>2</sup>
10	FOYER	43m <sup>2</sup>
11	OFFICE	62m <sup>2</sup>
12	OFFICE	42m <sup>2</sup>
13	OFFICE	41m <sup>2</sup>
14	OFFICE	47m <sup>2</sup>
15	OFFICE	79m <sup>2</sup>
16	OFFICE	40m <sup>2</sup>
17	STORAGE	8m <sup>2</sup>
18	OFFICE	42m <sup>2</sup>
19	OFFICE	48m <sup>2</sup>
20	MEETING ROOM	75m <sup>2</sup>
21	OFFICE	52m <sup>2</sup>
22	OFFICE	43m <sup>2</sup>
23	OFFICE	48m <sup>2</sup>
24	STORAGE	43m <sup>2</sup>
25	AC ROOM	15m <sup>2</sup>
26	SECRETARY	22m <sup>2</sup>
27	LOUNGE	110m <sup>2</sup>
28	TECHNICAL AREA	12m <sup>2</sup>
29	ELECTRIC ROOM	43m <sup>2</sup>
30	AC ROOM	15m <sup>2</sup>
31	LOUNGE	115m <sup>2</sup>
GROSS OFFICE AREA		1,440m <sup>2</sup>



2. FLOOR



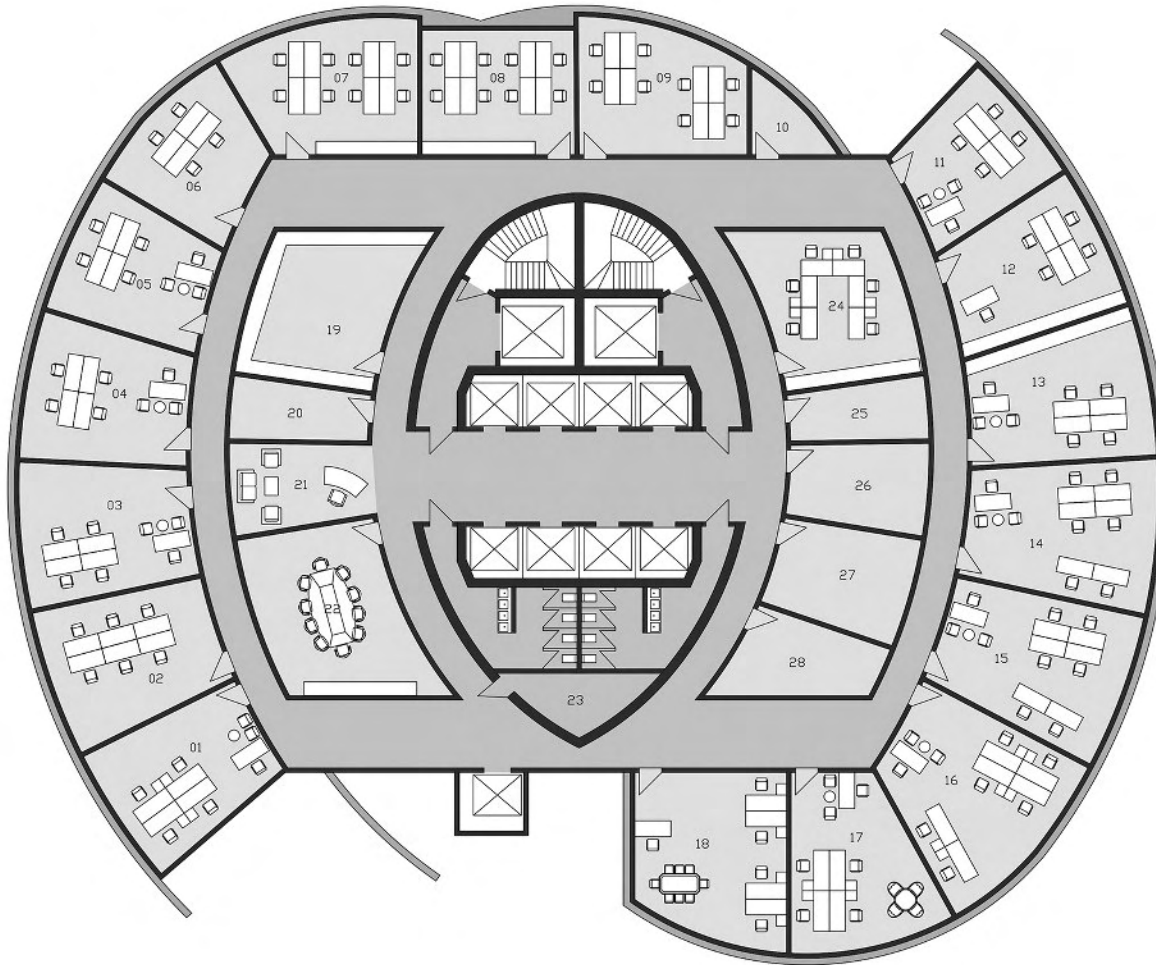

01	OFFICE	39m <sup>2</sup>
02	OFFICE	42m <sup>2</sup>
03	OFFICE	42m <sup>2</sup>
04	OFFICE	41m <sup>2</sup>
05	OFFICE	35m <sup>2</sup>
06	OFFICE	32m <sup>2</sup>
07	OFFICE	43m <sup>2</sup>
08	OFFICE	37m <sup>2</sup>
09	OFFICE	40m <sup>2</sup>
10	STORAGE	8m <sup>2</sup>
11	OFFICE	32m <sup>2</sup>
12	OFFICE	39m <sup>2</sup>
13	OFFICE	45m <sup>2</sup>
14	OFFICE	48m <sup>2</sup>
15	OFFICE	48m <sup>2</sup>
16	OFFICE	52m <sup>2</sup>
17	OFFICE	43m <sup>2</sup>
18	OFFICE	48m <sup>2</sup>
19	STORAGE	43m <sup>2</sup>
20	AC ROOM	15m <sup>2</sup>
21	SECRETARY	22m <sup>2</sup>
22	MEETING ROOM	48m <sup>2</sup>
23	TECHNICAL AREA	12m <sup>2</sup>
24	IT ROOM	43m <sup>2</sup>
25	AC ROOM	15m <sup>2</sup>
26	SERVICE ROOM	22m <sup>2</sup>
27	PRAYER ROOM	26m <sup>2</sup>
28	ELECTRIC ROOM	21m <sup>2</sup>
GROSS OFFICE AREA		1,065m <sup>2</sup>



0 5 10 m 1:200



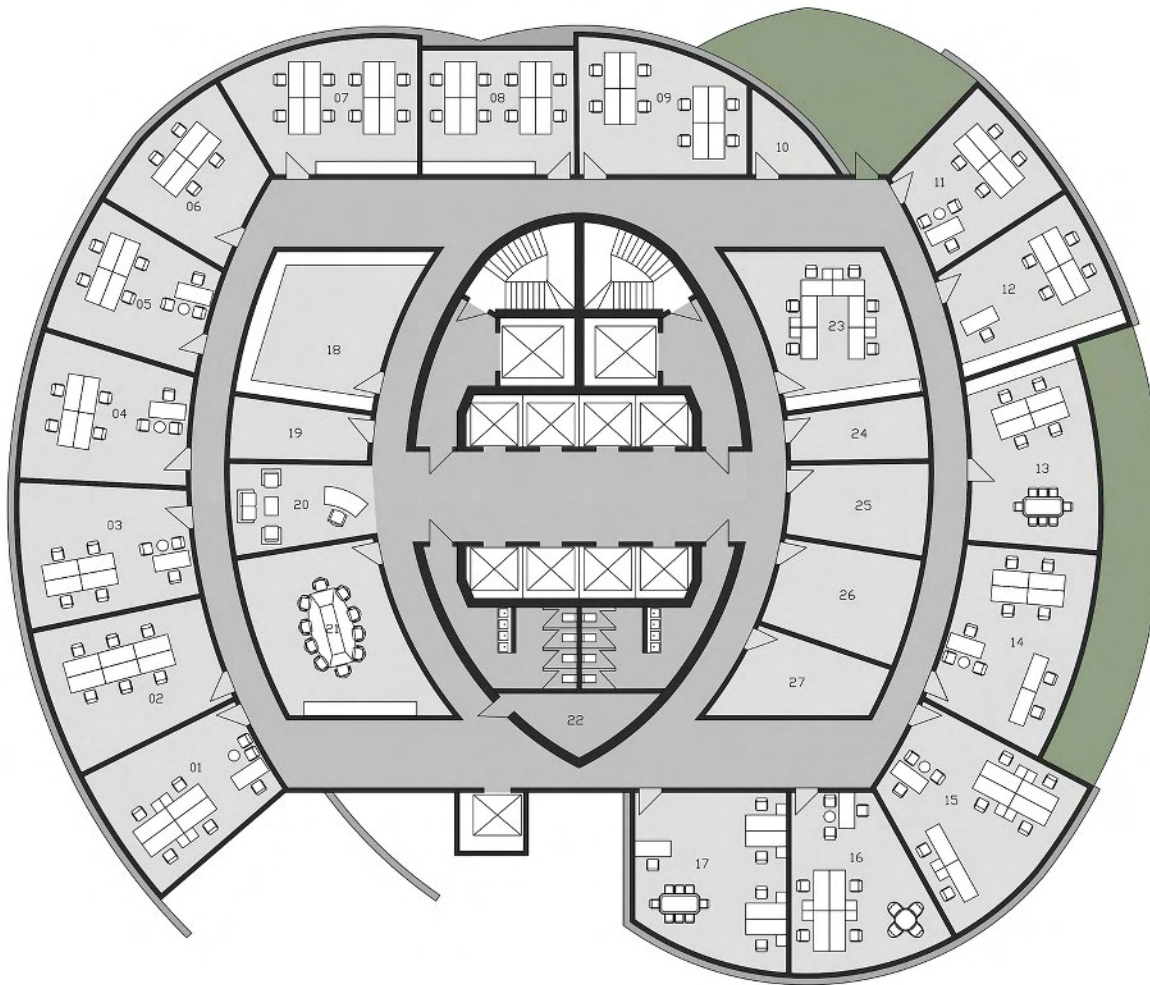

01	OFFICE	39m <sup>2</sup>
02	OFFICE	42m <sup>2</sup>
03	OFFICE	42m <sup>2</sup>
04	OFFICE	41m <sup>2</sup>
05	OFFICE	35m <sup>2</sup>
06	OFFICE	32m <sup>2</sup>
07	OFFICE	43m <sup>2</sup>
08	OFFICE	37m <sup>2</sup>
09	OFFICE	40m <sup>2</sup>
10	STORAGE	8m <sup>2</sup>
11	OFFICE	32m <sup>2</sup>
12	OFFICE	39m <sup>2</sup>
13	OFFICE	44m <sup>2</sup>
14	OFFICE	47m <sup>2</sup>
15	OFFICE	52m <sup>2</sup>
16	OFFICE	43m <sup>2</sup>
17	OFFICE	48m <sup>2</sup>
18	STORAGE	43m <sup>2</sup>
19	AC ROOM	15m <sup>2</sup>
20	SECRETARY	22m <sup>2</sup>
21	MEETING ROOM	48m <sup>2</sup>
22	TECHNICAL AREA	12m <sup>2</sup>
23	IT ROOM	43m <sup>2</sup>
24	AC ROOM	15m <sup>2</sup>
25	SERVICE ROOM	22m <sup>2</sup>
26	PRAYER ROOM	26m <sup>2</sup>
27	ELECTRIC ROOM	21m <sup>2</sup>
GROSS OFFICE AREA		1,013m <sup>2</sup>



0 5 10 m 1:200

8. FLOOR



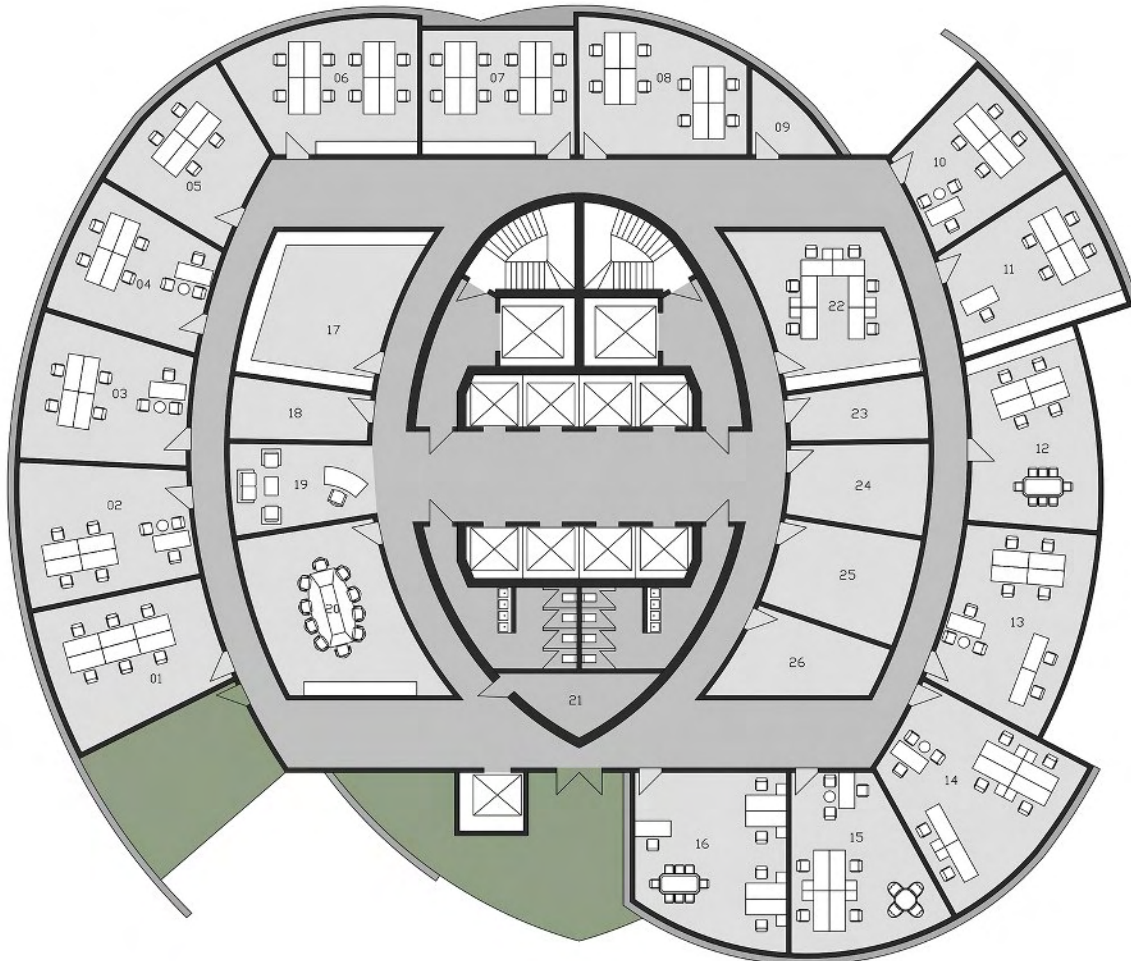

01	OFFICE	42m <sup>2</sup>
02	OFFICE	42m <sup>2</sup>
03	OFFICE	41m <sup>2</sup>
04	OFFICE	35m <sup>2</sup>
05	OFFICE	32m <sup>2</sup>
06	OFFICE	43m <sup>2</sup>
07	OFFICE	37m <sup>2</sup>
08	OFFICE	40m <sup>2</sup>
09	STORAGE	8m <sup>2</sup>
10	OFFICE	32m <sup>2</sup>
11	OFFICE	39m <sup>2</sup>
12	OFFICE	44m <sup>2</sup>
13	OFFICE	47m <sup>2</sup>
14	OFFICE	52m <sup>2</sup>
15	OFFICE	43m <sup>2</sup>
16	OFFICE	48m <sup>2</sup>
17	STORAGE	43m <sup>2</sup>
18	AC ROOM	15m <sup>2</sup>
19	SECRETARY	22m <sup>2</sup>
20	MEETING ROOM	48m <sup>2</sup>
21	TECHNICAL AREA	12m <sup>2</sup>
22	IT ROOM	43m <sup>2</sup>
23	AC ROOM	15m <sup>2</sup>
24	SERVICE ROOM	22m <sup>2</sup>
25	PRAYER ROOM	26m <sup>2</sup>
26	ELECTRIC ROOM	21m <sup>2</sup>
GROSS OFFICE AREA		971m <sup>2</sup>



8. FLOOR



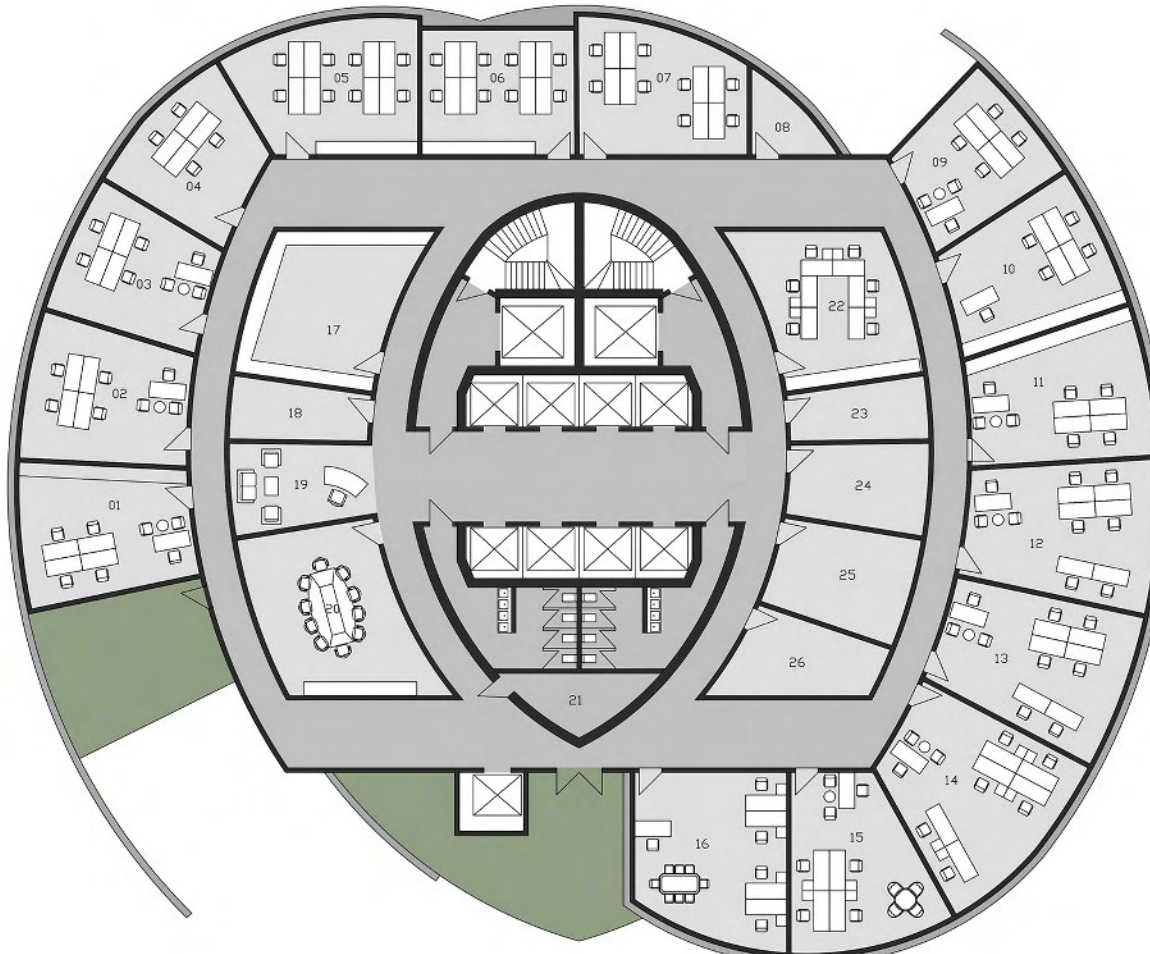

01	OFFICE	42m <sup>2</sup>
02	OFFICE	41m <sup>2</sup>
03	OFFICE	35m <sup>2</sup>
04	OFFICE	32m <sup>2</sup>
05	OFFICE	43m <sup>2</sup>
06	OFFICE	37m <sup>2</sup>
07	OFFICE	40m <sup>2</sup>
08	STORAGE	8m <sup>2</sup>
09	OFFICE	32m <sup>2</sup>
10	OFFICE	39m <sup>2</sup>
11	OFFICE	45m <sup>2</sup>
12	OFFICE	48m <sup>2</sup>
13	OFFICE	48m <sup>2</sup>
14	OFFICE	52m <sup>2</sup>
15	OFFICE	43m <sup>2</sup>
16	OFFICE	48m <sup>2</sup>
17	STORAGE	43m <sup>2</sup>
18	AC ROOM	15m <sup>2</sup>
19	SECRETARY	22m <sup>2</sup>
20	MEETING ROOM	48m <sup>2</sup>
21	TECHNICAL AREA	12m <sup>2</sup>
22	IT ROOM	43m <sup>2</sup>
23	AC ROOM	15m <sup>2</sup>
24	SERVICE ROOM	22m <sup>2</sup>
25	PRAYER ROOM	26m <sup>2</sup>
26	ELECTRIC ROOM	21m <sup>2</sup>
GROSS OFFICE AREA		978m <sup>2</sup>



10. FLOOR



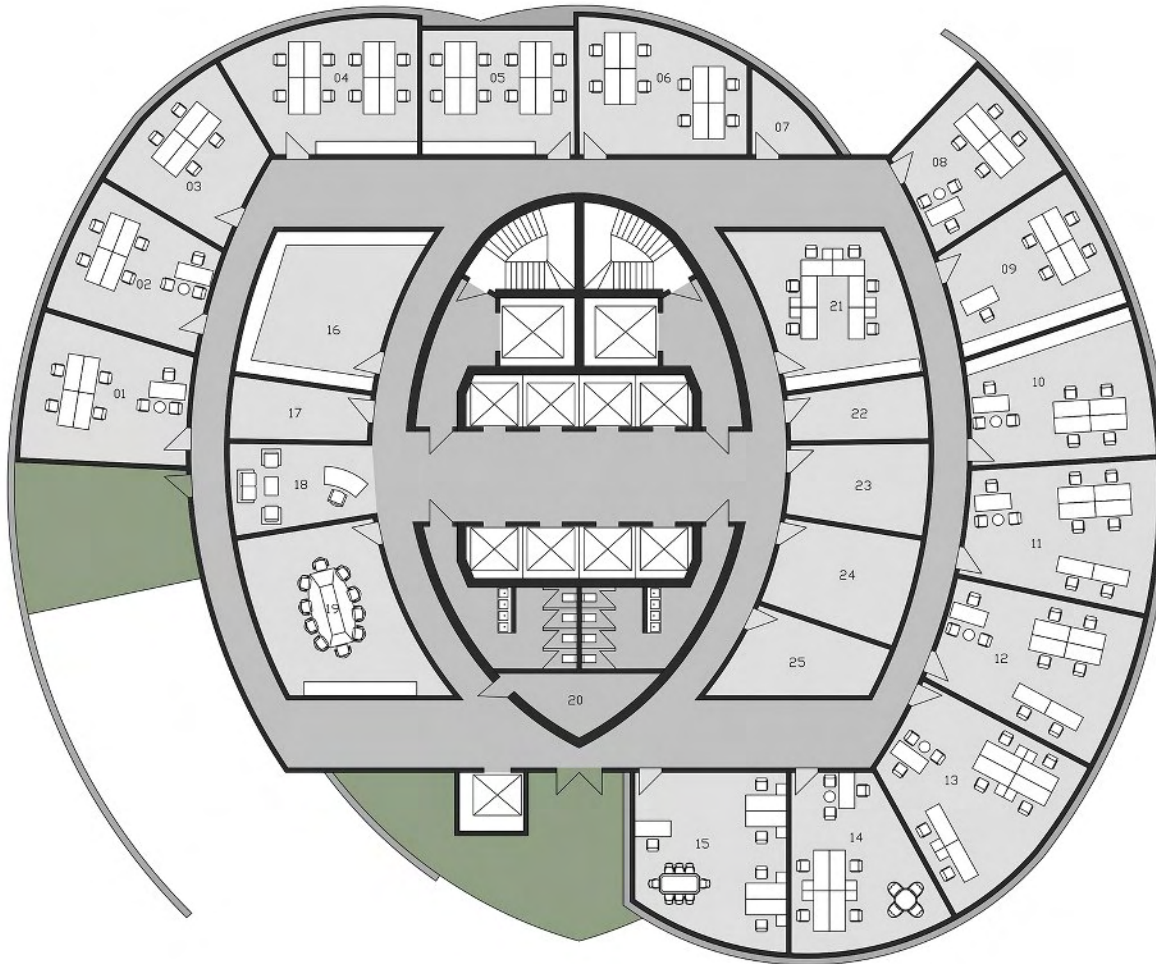

01	OFFICE	41m <sup>2</sup>
02	OFFICE	35m <sup>2</sup>
03	OFFICE	32m <sup>2</sup>
04	OFFICE	43m <sup>2</sup>
05	OFFICE	37m <sup>2</sup>
06	OFFICE	40m <sup>2</sup>
07	STORAGE	8m <sup>2</sup>
08	OFFICE	32m <sup>2</sup>
09	OFFICE	39m <sup>2</sup>
10	OFFICE	45m <sup>2</sup>
11	OFFICE	48m <sup>2</sup>
12	OFFICE	48m <sup>2</sup>
13	OFFICE	52m <sup>2</sup>
14	OFFICE	43m <sup>2</sup>
15	OFFICE	48m <sup>2</sup>
16	STORAGE	43m <sup>2</sup>
17	AC ROOM	15m <sup>2</sup>
18	SECRETARY	22m <sup>2</sup>
19	MEETING ROOM	48m <sup>2</sup>
20	TECHNICAL AREA	12m <sup>2</sup>
21	IT ROOM	43m <sup>2</sup>
22	AC ROOM	15m <sup>2</sup>
23	SERVICE ROOM	22m <sup>2</sup>
24	PRAYER ROOM	26m <sup>2</sup>
25	ELECTRIC ROOM	21m <sup>2</sup>
GROSS OFFICE AREA		978m <sup>2</sup>



0 5 10 m 1:200

11. FLOOR



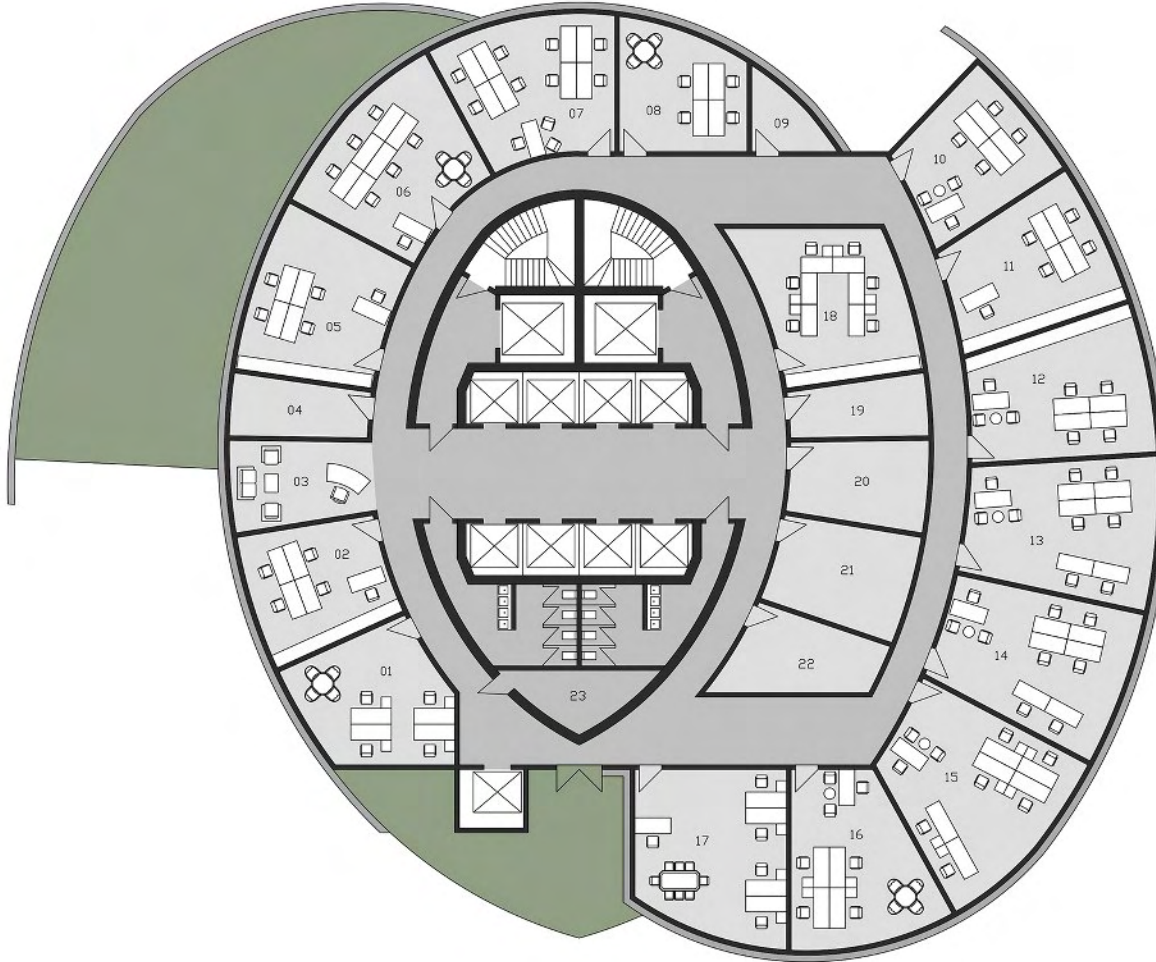

01	OFFICE	36m <sup>2</sup>
02	OFFICE	32m <sup>2</sup>
03	SECRETARY	22m <sup>2</sup>
04	AC ROOM	15m <sup>2</sup>
05	OFFICE	41m <sup>2</sup>
06	OFFICE	43m <sup>2</sup>
07	OFFICE	42m <sup>2</sup>
08	OFFICE	30m <sup>2</sup>
09	STORAGE	8m <sup>2</sup>
10	OFFICE	32m <sup>2</sup>
11	OFFICE	39m <sup>2</sup>
12	OFFICE	45m <sup>2</sup>
13	OFFICE	48m <sup>2</sup>
14	OFFICE	48m <sup>2</sup>
15	OFFICE	52m <sup>2</sup>
16	OFFICE	43m <sup>2</sup>
17	OFFICE	48m <sup>2</sup>
18	IT ROOM	43m <sup>2</sup>
19	AC ROOM	15m <sup>2</sup>
20	SERVICE ROOM	22m <sup>2</sup>
21	PRAYER ROOM	26m <sup>2</sup>
22	ELECTRIC ROOM	21m <sup>2</sup>
23	TECHNICAL AREA	12m <sup>2</sup>
GRSS OFFICE AREA		839m <sup>2</sup>

0 5 10 m 1:200

12. FLOOR



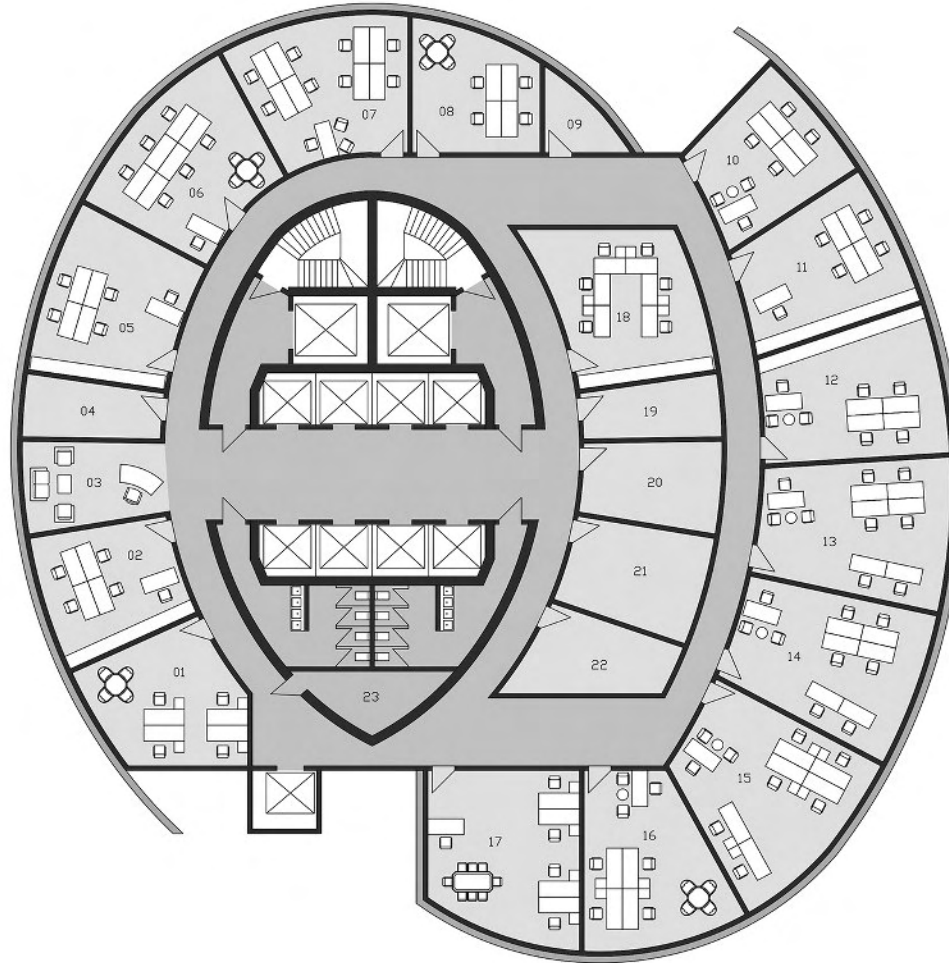

01 OFFICE	36m <sup>2</sup>
02 OFFICE	32m <sup>2</sup>
03 SECRETARY	22m <sup>2</sup>
04 AC ROOM	15m <sup>2</sup>
05 OFFICE	41m <sup>2</sup>
06 OFFICE	43m <sup>2</sup>
07 OFFICE	42m <sup>2</sup>
08 OFFICE	30m <sup>2</sup>
09 STORAGE	8m <sup>2</sup>
10 OFFICE	32m <sup>2</sup>
11 OFFICE	39m <sup>2</sup>
12 OFFICE	45m <sup>2</sup>
13 OFFICE	48m <sup>2</sup>
14 OFFICE	48m <sup>2</sup>
15 OFFICE	52m <sup>2</sup>
16 OFFICE	43m <sup>2</sup>
17 OFFICE	48m <sup>2</sup>
18 IT ROOM	43m <sup>2</sup>
19 AC ROOM	15m <sup>2</sup>
20 SERVICE ROOM	22m <sup>2</sup>
21 PRAYER ROOM	26m <sup>2</sup>
22 ELECTRIC ROOM	21m <sup>2</sup>
23 TECHNICAL AREA	12m <sup>2</sup>
<b>GRSS OFFICE AREA</b>	<b>839m<sup>2</sup></b>



0 5 10 m 1:200

13.-15. FLOOR



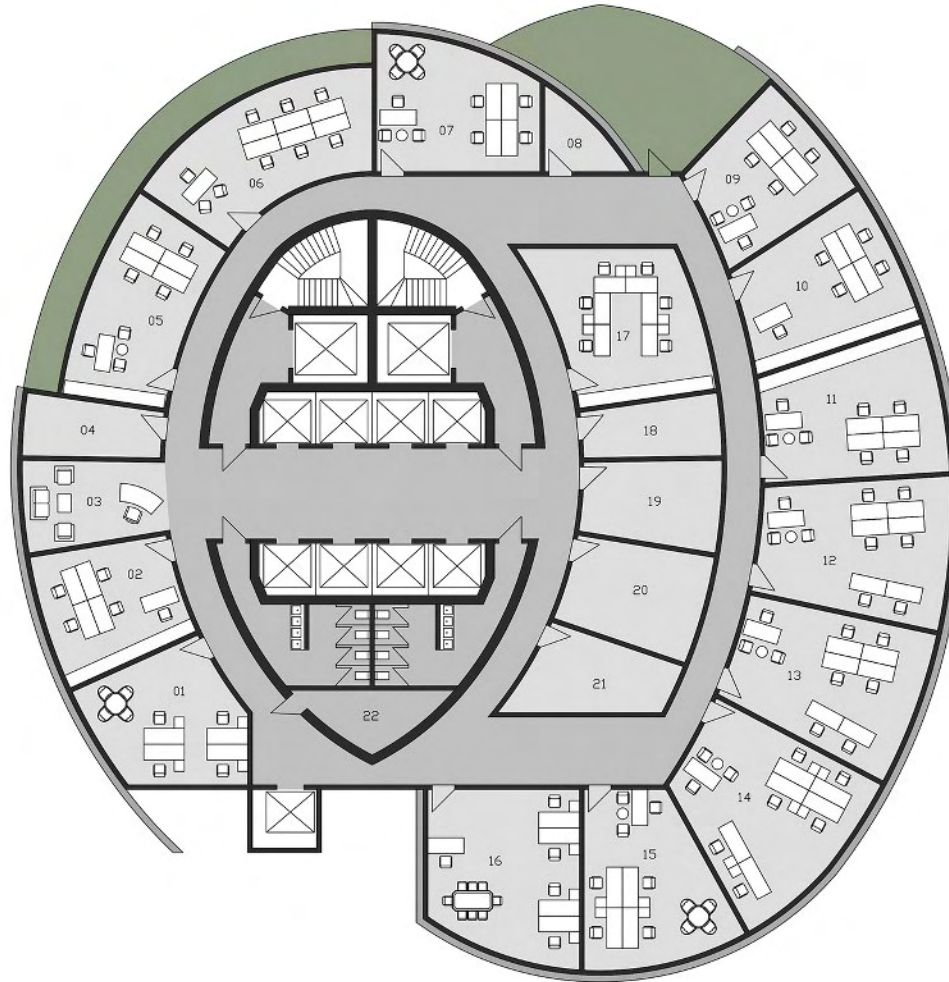

01	OFFICE	36m <sup>2</sup>
02	OFFICE	32m <sup>2</sup>
03	SECRETARY	22m <sup>2</sup>
04	AC ROOM	15m <sup>2</sup>
05	OFFICE	40m <sup>2</sup>
06	OFFICE	45m <sup>2</sup>
07	OFFICE	39m <sup>2</sup>
08	STORAGE	8m <sup>2</sup>
09	OFFICE	32m <sup>2</sup>
10	OFFICE	39m <sup>2</sup>
11	OFFICE	45m <sup>2</sup>
12	OFFICE	48m <sup>2</sup>
13	OFFICE	48m <sup>2</sup>
14	OFFICE	52m <sup>2</sup>
15	OFFICE	43m <sup>2</sup>
16	OFFICE	48m <sup>2</sup>
17	IT ROOM	43m <sup>2</sup>
18	AC ROOM	15m <sup>2</sup>
19	SERVICE ROOM	22m <sup>2</sup>
20	PRAYER ROOM	26m <sup>2</sup>
21	ELECTRIC ROOM	21m <sup>2</sup>
22	TECHNICAL AREA	12m <sup>2</sup>
GRSS OFFICE AREA		839m <sup>2</sup>



0 5 10 m 1:200



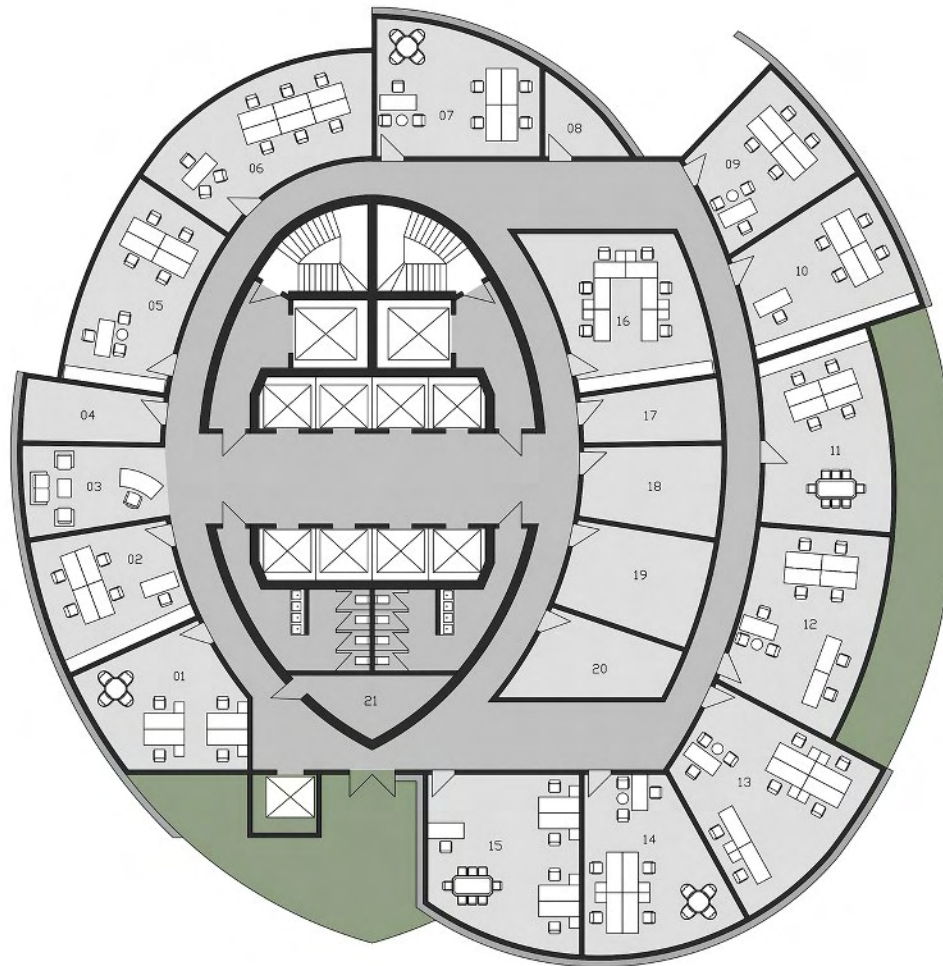

01	OFFICE	36m <sup>2</sup>
02	OFFICE	32m <sup>2</sup>
03	SECRETARY	22m <sup>2</sup>
04	AC ROOM	15m <sup>2</sup>
05	OFFICE	40m <sup>2</sup>
06	OFFICE	45m <sup>2</sup>
07	OFFICE	39m <sup>2</sup>
08	STORAGE	8m <sup>2</sup>
09	OFFICE	32m <sup>2</sup>
10	OFFICE	39m <sup>2</sup>
11	OFFICE	44m <sup>2</sup>
12	OFFICE	47m <sup>2</sup>
13	OFFICE	52m <sup>2</sup>
14	OFFICE	43m <sup>2</sup>
15	OFFICE	48m <sup>2</sup>
16	IT ROOM	43m <sup>2</sup>
17	AC ROOM	15m <sup>2</sup>
18	SERVICE ROOM	22m <sup>2</sup>
19	PRAYER ROOM	26m <sup>2</sup>
20	ELECTRIC ROOM	21m <sup>2</sup>
21	TECHNICAL AREA	12m <sup>2</sup>
GRSS OFFICE AREA		752m <sup>2</sup>



0 5 10 m 1:200

17. FLOOR



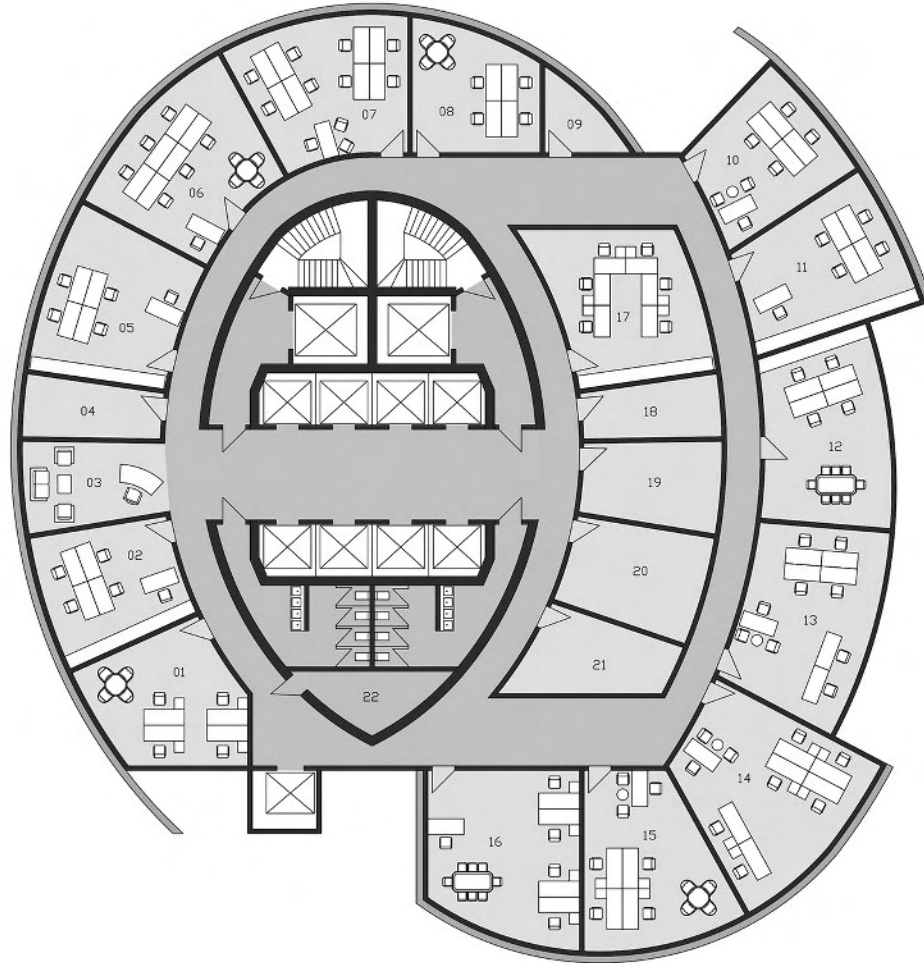

01	OFFICE	36m <sup>2</sup>
02	OFFICE	32m <sup>2</sup>
03	SECRETARY	22m <sup>2</sup>
04	AC ROOM	15m <sup>2</sup>
05	OFFICE	41m <sup>2</sup>
06	OFFICE	43m <sup>2</sup>
07	OFFICE	42m <sup>2</sup>
08	OFFICE	30m <sup>2</sup>
09	STORAGE	8m <sup>2</sup>
10	OFFICE	32m <sup>2</sup>
11	OFFICE	39m <sup>2</sup>
12	OFFICE	44m <sup>2</sup>
13	OFFICE	47m <sup>2</sup>
14	OFFICE	52m <sup>2</sup>
15	OFFICE	43m <sup>2</sup>
16	OFFICE	48m <sup>2</sup>
17	IT ROOM	43m <sup>2</sup>
18	AC ROOM	15m <sup>2</sup>
19	SERVICE ROOM	22m <sup>2</sup>
20	PRAYER ROOM	26m <sup>2</sup>
21	ELECTRIC ROOM	21m <sup>2</sup>
22	TECHNICAL AREA	12m <sup>2</sup>
GRSS OFFICE AREA		787m <sup>2</sup>



0 5 10 m 1:200

18.-19. FLOOR



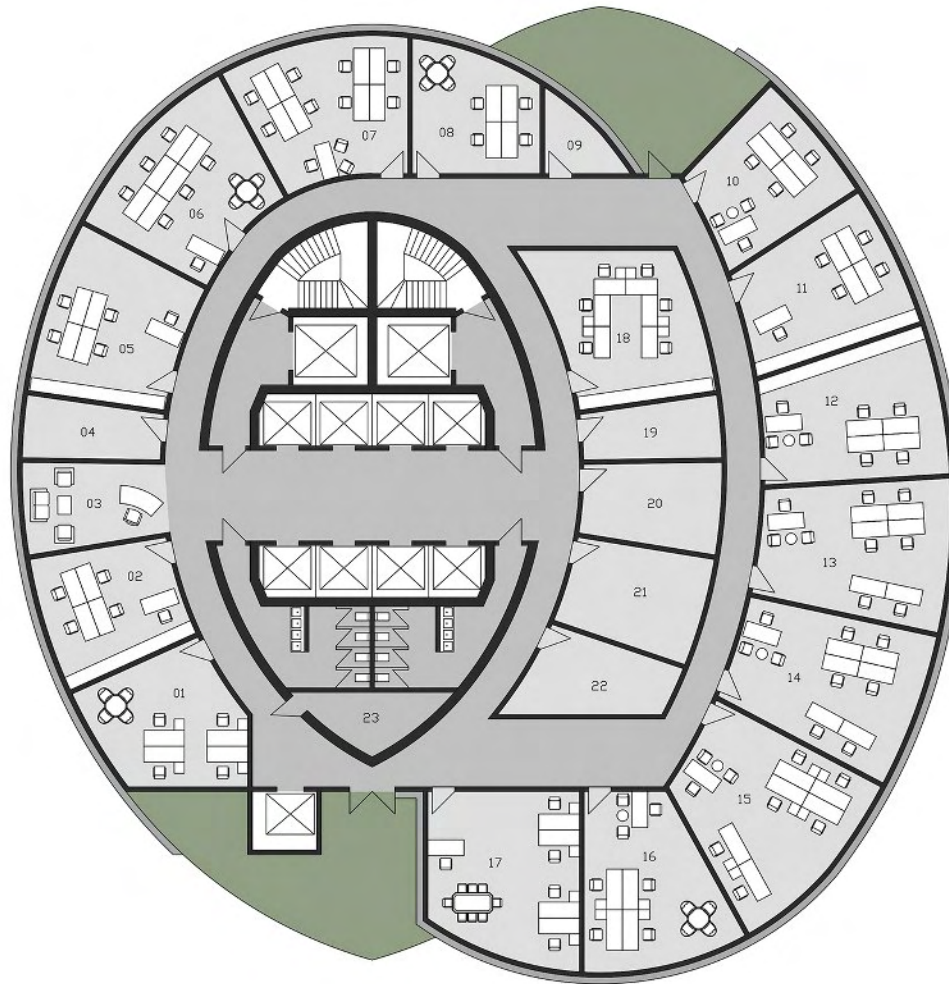

01 OFFICE	36m <sup>2</sup>
02 OFFICE	32m <sup>2</sup>
03 SECRETARY	22m <sup>2</sup>
04 AC ROOM	15m <sup>2</sup>
05 OFFICE	41m <sup>2</sup>
06 OFFICE	43m <sup>2</sup>
07 OFFICE	42m <sup>2</sup>
08 OFFICE	30m <sup>2</sup>
09 STORAGE	8m <sup>2</sup>
10 OFFICE	32m <sup>2</sup>
11 OFFICE	39m <sup>2</sup>
12 OFFICE	45m <sup>2</sup>
13 OFFICE	48m <sup>2</sup>
14 OFFICE	48m <sup>2</sup>
15 OFFICE	52m <sup>2</sup>
16 OFFICE	43m <sup>2</sup>
17 OFFICE	48m <sup>2</sup>
18 IT ROOM	43m <sup>2</sup>
19 AC ROOM	15m <sup>2</sup>
20 SERVICE ROOM	22m <sup>2</sup>
21 PRAYER ROOM	26m <sup>2</sup>
22 ELECTRIC ROOM	21m <sup>2</sup>
23 TECHNICAL AREA	12m <sup>2</sup>
<b>GRSS OFFICE AREA</b>	<b>839m<sup>2</sup></b>



0 5 10 m 1:200

20-22. FLOOR



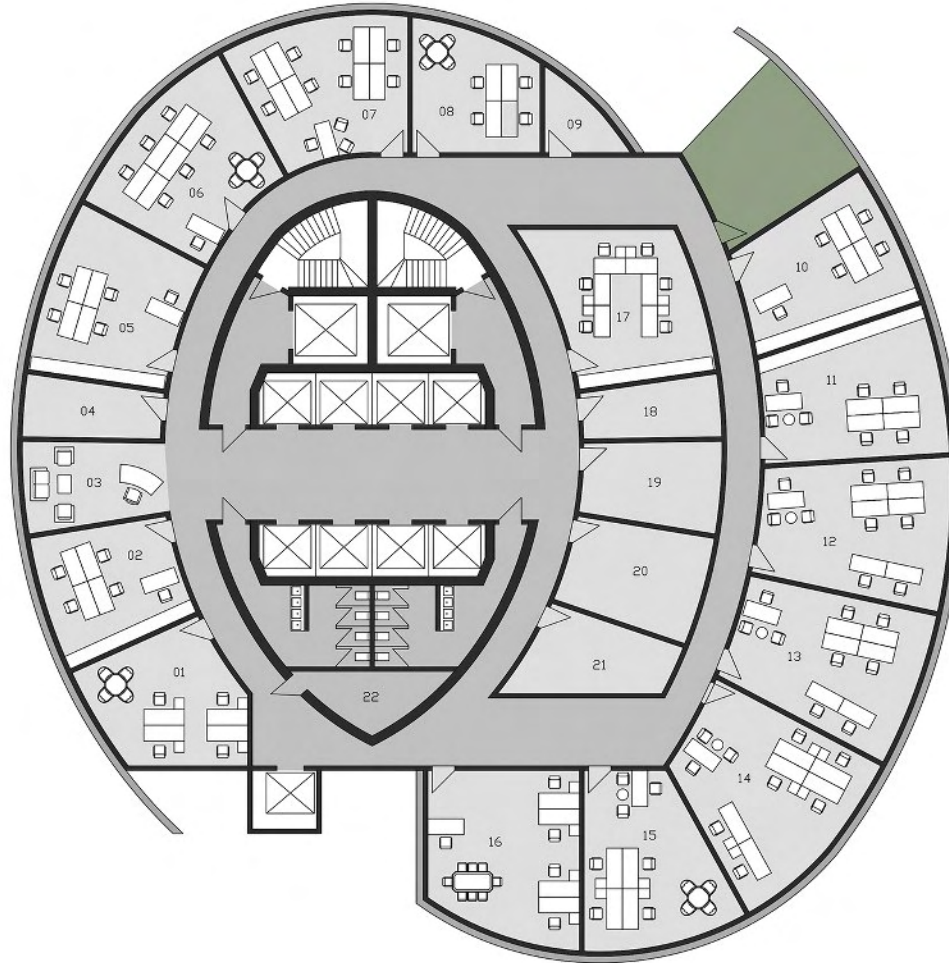

01	OFFICE	36m <sup>2</sup>
02	OFFICE	32m <sup>2</sup>
03	SECRETARY	22m <sup>2</sup>
04	AC ROOM	15m <sup>2</sup>
05	OFFICE	41m <sup>2</sup>
06	OFFICE	43m <sup>2</sup>
07	OFFICE	42m <sup>2</sup>
08	OFFICE	30m <sup>2</sup>
09	STORAGE	8m <sup>2</sup>
10	OFFICE	39m <sup>2</sup>
11	OFFICE	45m <sup>2</sup>
12	OFFICE	48m <sup>2</sup>
13	OFFICE	48m <sup>2</sup>
14	OFFICE	52m <sup>2</sup>
15	OFFICE	43m <sup>2</sup>
16	OFFICE	48m <sup>2</sup>
17	IT ROOM	43m <sup>2</sup>
18	AC ROOM	15m <sup>2</sup>
19	SERVICE ROOM	22m <sup>2</sup>
20	PRAYER ROOM	26m <sup>2</sup>
21	ELECTRIC ROOM	21m <sup>2</sup>
22	TECHNICAL AREA	12m <sup>2</sup>
GRSS OFFICE AREA		804m <sup>2</sup>



0 5 10 m 1:200

23. FLOOR



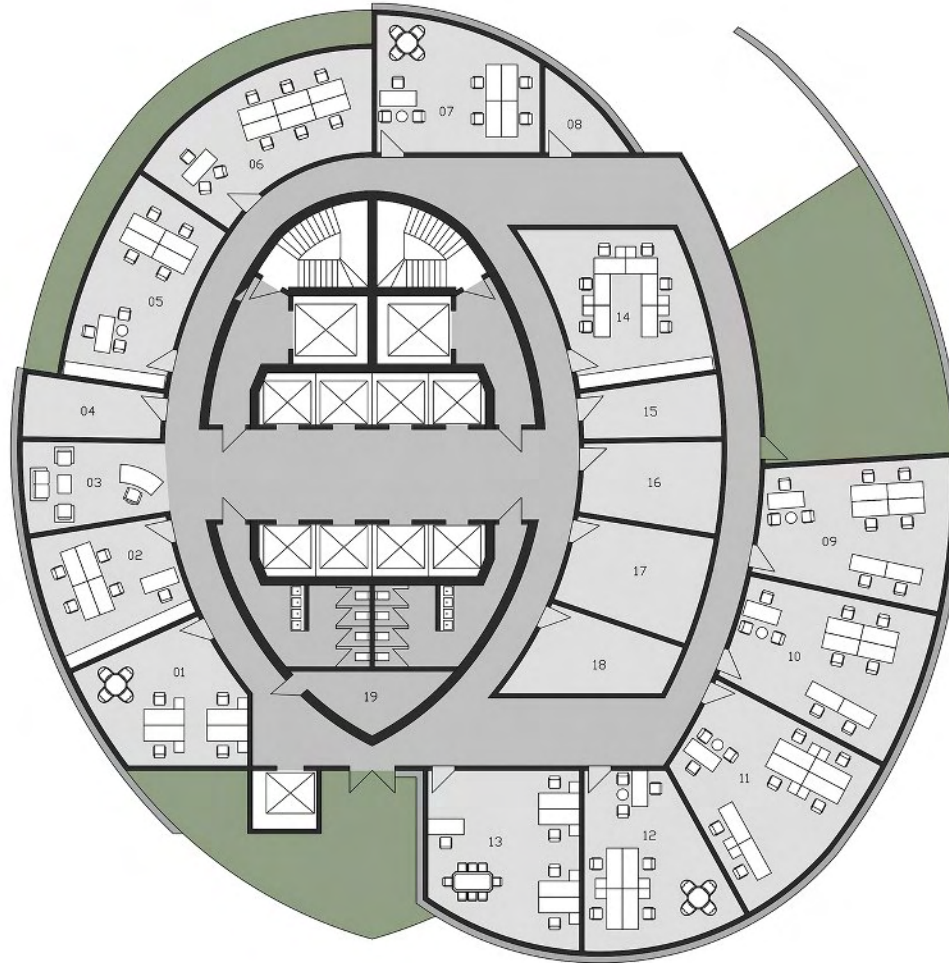

01	OFFICE	36m <sup>2</sup>
02	OFFICE	32m <sup>2</sup>
03	SECRETARY	22m <sup>2</sup>
04	AC ROOM	15m <sup>2</sup>
05	OFFICE	40m <sup>2</sup>
06	OFFICE	45m <sup>2</sup>
07	OFFICE	39m <sup>2</sup>
08	STORAGE	8m <sup>2</sup>
09	OFFICE	48m <sup>2</sup>
10	OFFICE	48m <sup>2</sup>
11	OFFICE	52m <sup>2</sup>
12	OFFICE	43m <sup>2</sup>
13	OFFICE	48m <sup>2</sup>
14	IT ROOM	43m <sup>2</sup>
15	AC ROOM	15m <sup>2</sup>
16	SERVICE ROOM	22m <sup>2</sup>
17	PRAYER ROOM	26m <sup>2</sup>
18	ELECTRIC ROOM	21m <sup>2</sup>
19	TECHNICAL AREA	12m <sup>2</sup>
GRSSS OFFICE AREA		681m <sup>2</sup>



0 5 10 m 1:200

24. FLOOR



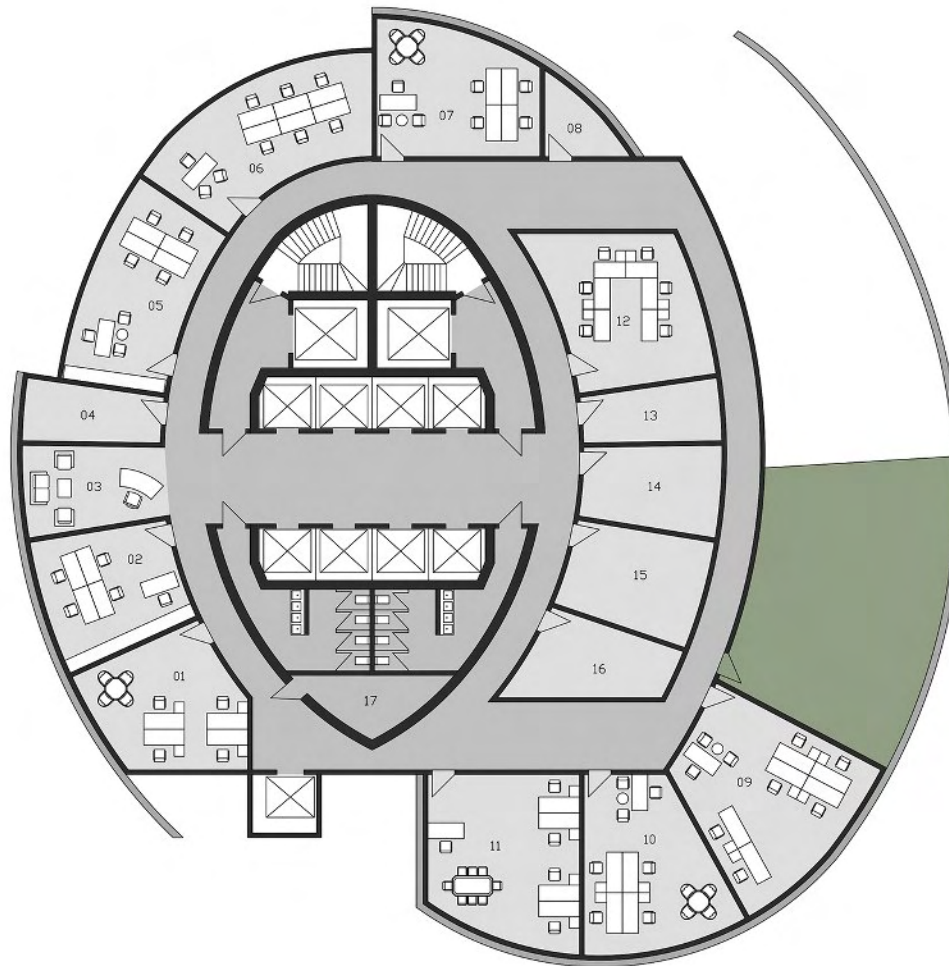

01	OFFICE	36m <sup>2</sup>
02	OFFICE	32m <sup>2</sup>
03	SECRETARY	22m <sup>2</sup>
04	AC ROOM	15m <sup>2</sup>
05	OFFICE	40m <sup>2</sup>
06	OFFICE	45m <sup>2</sup>
07	OFFICE	39m <sup>2</sup>
08	STORAGE	8m <sup>2</sup>
09	OFFICE	52m <sup>2</sup>
10	OFFICE	43m <sup>2</sup>
11	OFFICE	48m <sup>2</sup>
12	IT ROOM	43m <sup>2</sup>
13	AC ROOM	15m <sup>2</sup>
14	SERVICE ROOM	22m <sup>2</sup>
15	PRAYER ROOM	26m <sup>2</sup>
16	ELECTRIC ROOM	21m <sup>2</sup>
17	TECHNICAL AREA	12m <sup>2</sup>
GRSS OFFICE AREA		579m <sup>2</sup>



0 5 10 m 1:200

25. FLOOR

egelintidore  
**EID**  
 construction

**DORE**  
 ARCHITECTS



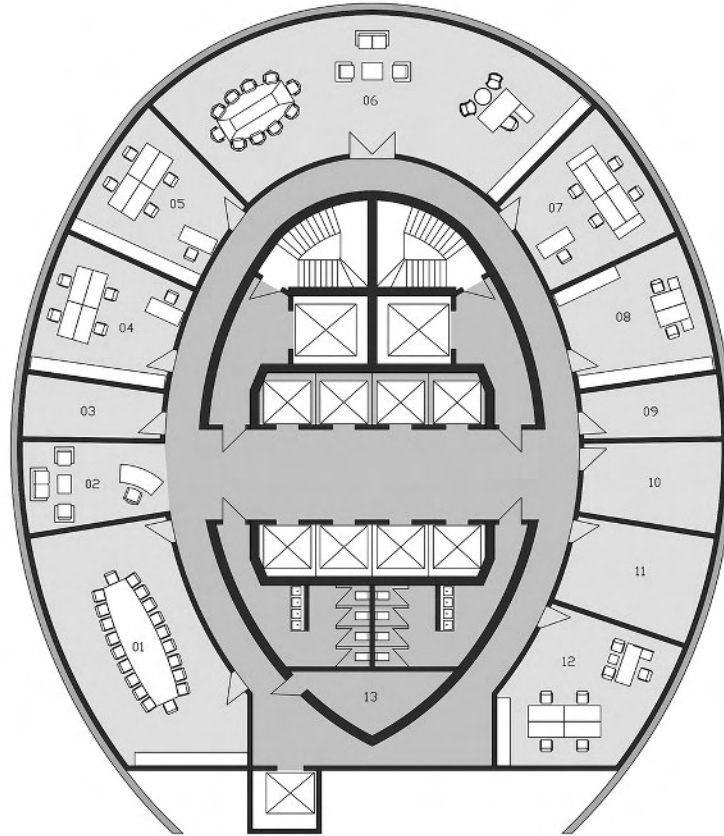

01	MEETING ROOM	69m <sup>2</sup>
02	SECRETARY	22m <sup>2</sup>
03	AC ROOM	15m <sup>2</sup>
04	OFFICE	32m <sup>2</sup>
05	OFFICE	32m <sup>2</sup>
06	MANAGER	102m <sup>2</sup>
07	OFFICE	33m <sup>2</sup>
08	IT ROOM	32m <sup>2</sup>
09	AC ROOM	15m <sup>2</sup>
10	SERVICE ROOM	22m <sup>2</sup>
11	PRAYER ROOM	26m <sup>2</sup>
12	OFFICE	41m <sup>2</sup>
13	TECHNICAL AREA	12m <sup>2</sup>
GRDSS OFFICE AREA		422m <sup>2</sup>



0 5 10 m 1:200

26. FLOOR



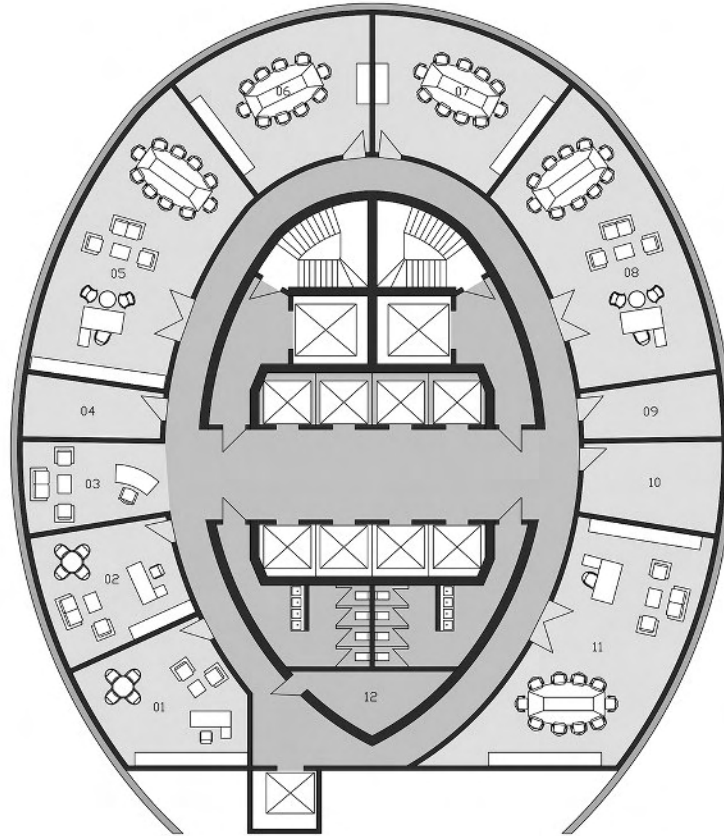

01	ASSISTANT MANAGER	35m <sup>2</sup>
02	ASSISTANT MANAGER	32m <sup>2</sup>
03	SECRETARY	22m <sup>2</sup>
04	AC ROOM	15m <sup>2</sup>
05	MANAGER	72m <sup>2</sup>
06	MEETING ROOM	45m <sup>2</sup>
07	MEETING ROOM	45m <sup>2</sup>
08	MANAGER	72m <sup>2</sup>
09	AC ROOM	15m <sup>2</sup>
10	SERVICE ROOM	22m <sup>2</sup>
11	MANAGER	74m <sup>2</sup>
12	TECHNICAL AREA	12m <sup>2</sup>



0 5 10 m 1:200

27. FLOOR



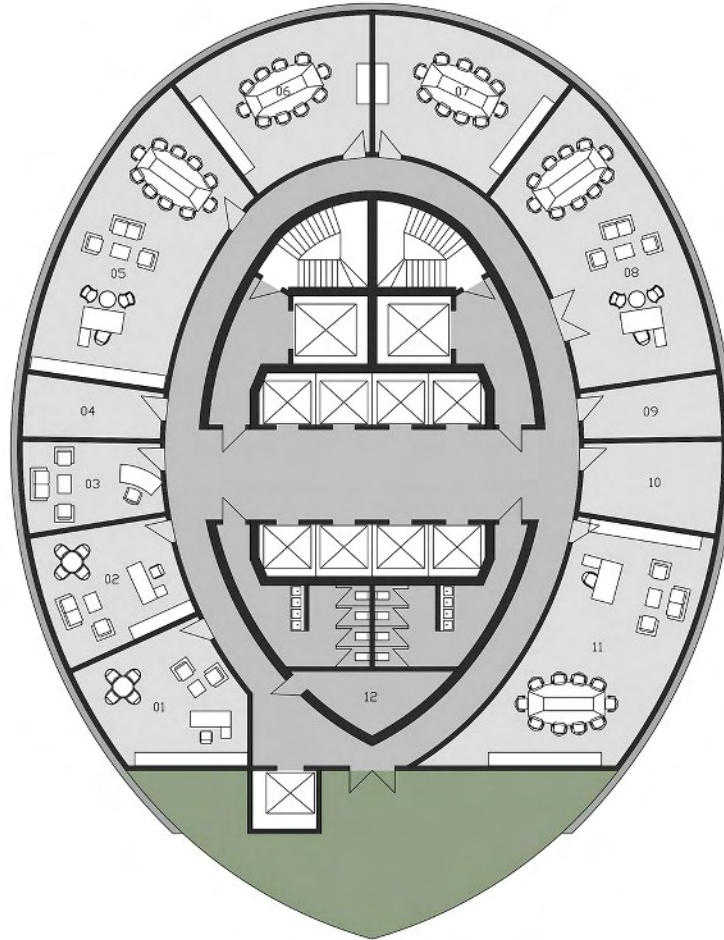

01	ASSISTANT MANAGER	35m <sup>2</sup>
02	ASSISTANT MANAGER	32m <sup>2</sup>
03	SECRETARY	22m <sup>2</sup>
04	AC ROOM	15m <sup>2</sup>
05	MANAGER	72m <sup>2</sup>
06	MEETING ROOM	45m <sup>2</sup>
07	MEETING ROOM	45m <sup>2</sup>
08	MANAGER	72m <sup>2</sup>
09	AC ROOM	15m <sup>2</sup>
10	SERVICE ROOM	22m <sup>2</sup>
11	MANAGER	74m <sup>2</sup>
12	TECHNICAL AREA	12m <sup>2</sup>



0 5 10 m 1:200

28.-29. FLOOR



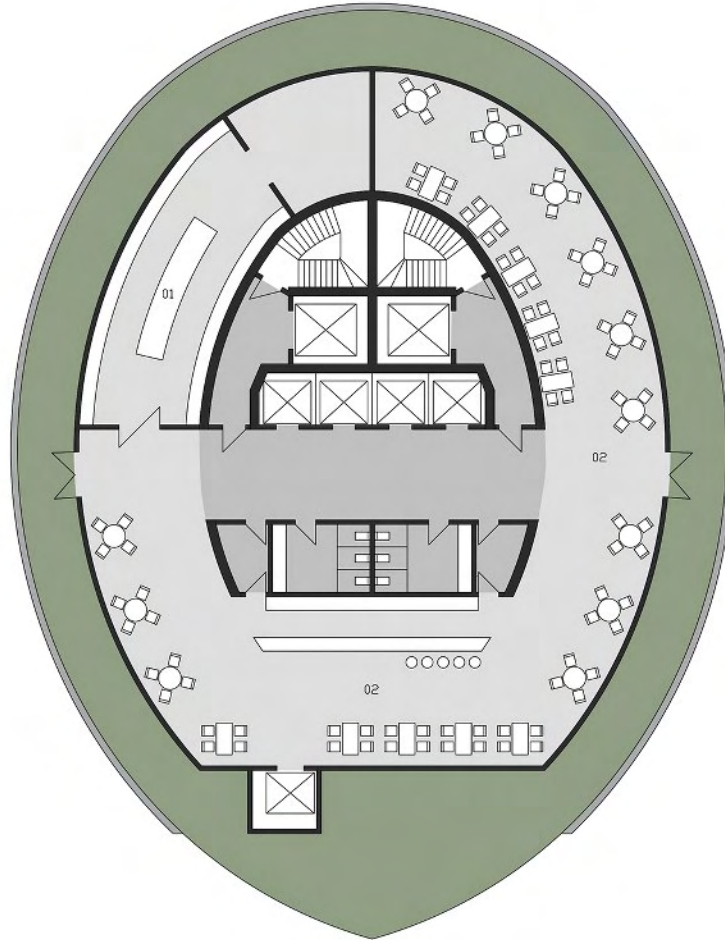

01	KITCHEN	96m <sup>2</sup>
02	RESTAURANT	324m <sup>2</sup>



30. FLOOR